



CATÁLOGO DE PRODUCTOS

2026



www.industriasjapan.com



INDUSTRIAS JAPAN S.A.

Fabricantes de partes para motocicletas

Live safely

NUESTRA HISTORIA

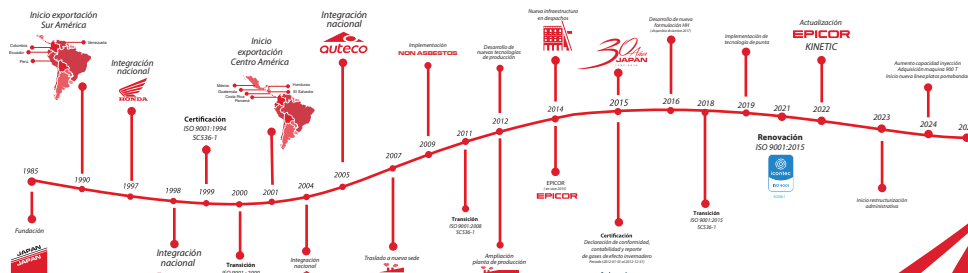

¿QUÉ ES EL COEFICIENTE DE FRICCIÓN?

Las características de fricción de las bandas y pastillas de freno, se miden por el comportamiento del coeficiente de fricción del material de desgaste en pruebas específicas de laboratorio. La norma americana SAE J866 ha clasificado los materiales en 7 niveles de acuerdo con rangos de fricción, los cuales se identifican con 2 letras, una representa el coeficiente de fricción normal o en frío y la segunda su comportamiento en caliente. En frenos, los niveles E y F corresponden a rangos de fricción corrientes y los niveles G y H, representan altos coeficientes de fricción.

Clasificación de niveles de fricción Según SAE J866 (CHASE)			
COEFICIENTE DE FRICCIÓN	CÓDIGO DE FRICCIÓN		
	FRÍO	CALIENTE	
0.45 - 0.55 PREMIUM	G	G	
0.45 - 0.55 PREMIUM	G	G	
0.45 - 0.55 High Performance	HH/GG	HH/GG	
Mayor a 0.55 Alto Desempeño/ High Performance	H	H	



Coeficiente de fricción
GG

Premium para motos de 80 cc. a 250 cc.



Coeficiente de fricción
HH y GG

Alto desempeño para motos de 300 cc. en adelante



Coeficiente de fricción
HH

High Performance



*(HH y HH orientada solo para motos de carrera o ambientes de alta exigencia).

INDUSTRIAS JAPAN S.A fabrica los materiales de fricción de las bandas y pastillas con coeficientes **GG** para motocicletas del mercado tradicional y coeficiente **HH** para frenos en motocicletas de alto cilindraje.

CLASIFICACIÓN PASTILLAS JAPAN



Pastillas de freno **JAPAN**
Premium Organics



Calidad *Premium*

Motocicletas de trabajo con gran exigencia de frenado en movilidad de alto tráfico.

Tipo *Orgánico* a base de fibras minerales y orgánicas, elastómeros, partículas activadoras y reguladoras del coeficiente de fricción; y resinas aglomerantes.

Mayor coeficiente de fricción para una respuesta de frenado más rápida. Menor distancia de parada.



Coeficiente de fricción
 μ : 0.45 - 0.55



Pastillas de freno **JAPAN**
Premium Semimetallics



Calidad *Premium*

Motocicletas de calle y todoterreno con gran exigencia de frenado. Ideales en terrenos destapados y estilos de conducción más agresivos.

Tipo *Orgánico* a base de fibras minerales y fibras de acero.

Mayor coeficiente de fricción para una respuesta de frenado más rápida. Menor distancia de parada.



Coeficiente de fricción
 μ : 0.45 - 0.55



Pastillas de freno **JAPAN**
Racing



Freno
DELANTERO



Pastillas de freno **JAPAN**
Racing



Freno
TRASERO

Calidad High Performance

Motocicletas de alto cilindraje (> 250 cc), Con gran exigencia de frenado en diferentes estilos de conducción desde moderado hasta deportivo.

Compuesto: *Orgánico* a base de fibras minerales, polvos metálicos, elementos activadores y reguladores del coeficiente de fricción y resina aglomerante. Contiene partículas especiales y platina con recubrimiento en cobre para alta disipación de calor. Productos con alto coeficiente de fricción: Pastillas delanteras con nivel HH y traseras con nivel GG.



Coeficiente de fricción
Delanteras μ : ≥ 0.55
Traseras μ : 0.45 - 0.55



JAPAN
Bike



Pastillas de freno **JAPAN**

COMPETITION PRO

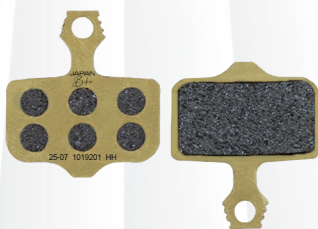

Pastillas de freno con un material de fricción de muy alto coeficiente (HH). La platina de respaldo incorpora un sistema de retención por grafilado que mejora la adherencia del compuesto.

Son productos totalmente libres de asbesto, compuestos por fibras minerales, fibras metálicas, partículas especiales para la alta disipación de calor, resina aglomerante, elementos activadores y reguladores del coeficiente de fricción. Por su naturaleza orgánica, son pastillas suaves que protegen los discos de freno contra el desgaste excesivo.

El nivel de fricción es HH, tanto en las pastillas delanteras como en las traseras, Clasificando estas pastillas como un producto High Performance.



CLASIFICACIÓN BANDAS JAPAN

Bandas
Nacionales JAPAN
Premium

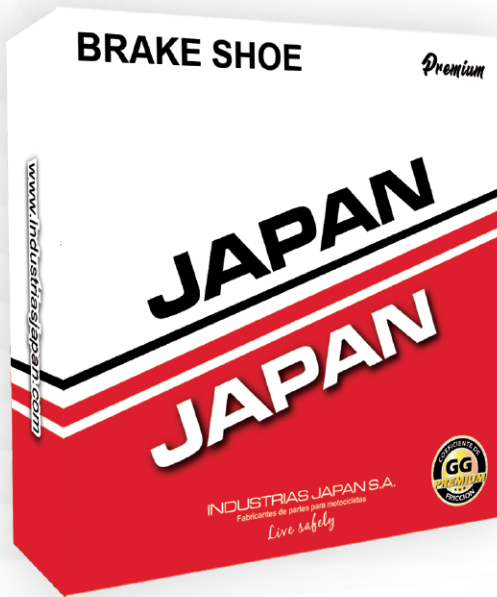

Bandas
Internacionales JAPAN
Premium



Calidad *Premium*

Motocicletas de trabajo con gran exigencia de frenado en movilidad de alto tráfico.

Tipo *Orgánico* a base de fibras minerales y orgánicas, elastómeros, partículas activadoras y reguladoras del coeficiente de fricción; y resinas aglomerantes.

Mayor coeficiente de fricción para una respuesta de frenado más rápida. Menor distancia de parada.



Coeficiente de fricción
 μ : 0.45 - 0.55



BANDAS DE FRENO



Aluminio de alta resistencia
y duración Refuerzo
en acero templado:
Evita la deformación de
las zapatas.



El material de fricción contiene
componentes Anti - ruido **coeficiente
de fricción GG** que clasifica este
producto con desempeño **PREMIUM**
(mejor que original y otros nacionales
e importados en su mayoría FF).



Las bandas de freno de INDUSTRIAS JAPAN S.A son el resultado de mas de **30 años de trabajo y mejora continua**. Las zapatas son fabricadas en aleación de Aluminio bajo estándares japoneses, por proceso de inyección a presión (**DIE CASTING TECHNOLOGY**), que garantizan una alta resistencia mecánica.

El material de fricción, totalmente libre de asbesto, ha sido desarrollado con el apoyo de centros de investigación y desarrollo en Estados Unidos y Alemania, garantizando un desempeño seguro y estable en diferentes condiciones climáticas.

El coeficiente de fricción y el desgaste son controlados continuamente con **pruebas de laboratorio bajo norma JIS D4411 (Japan Industrial Standard) y SAE J661 (Automotive Engineering)**.

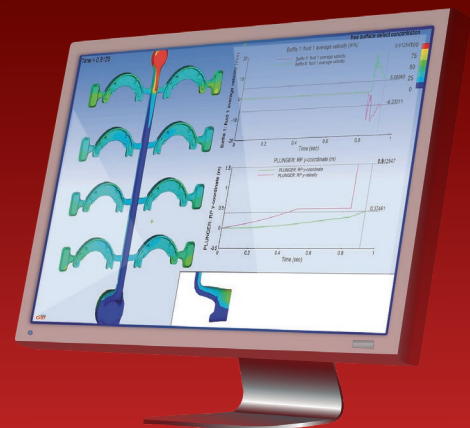

¿CÓMO MEDIR NUESTRAS BANDAS?

CÓD. JAPAN
01011

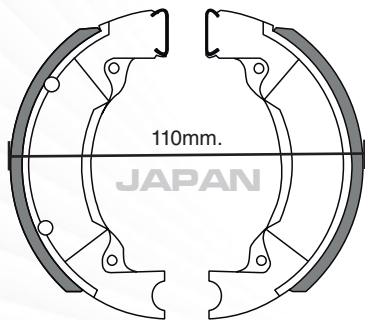

CÓD. ORIGINAL
296-25330-00

110 x 25 mm.	
DIÁMETRO DE LA ZAPATA	ANCHO DE LA ZAPATA
110mm.	25mm.



Cuadro de diámetros (mm.)
de las bandas de freno

Colocar la banda sobre las líneas
semicirculares para saber el
diámetro de la banda





BANDAS DE FRENO

LIBRES DE ASBESTO

1

Aluminio de alta resistencia y duración
Refuerzo en acero templado: Evita la deformación de las zapatas.

2

Material de Fricción LIBRE DE ASBESTO
Contribuye al cuidado de la salud y la preservación del medio ambiente.

3

El material de fricción contiene componentes Anti - ruido coeficiente de fricción GG que clasifica este producto con desempeño PREMIUM (mejor que original y otros nacionales e importados en su mayoría FF).

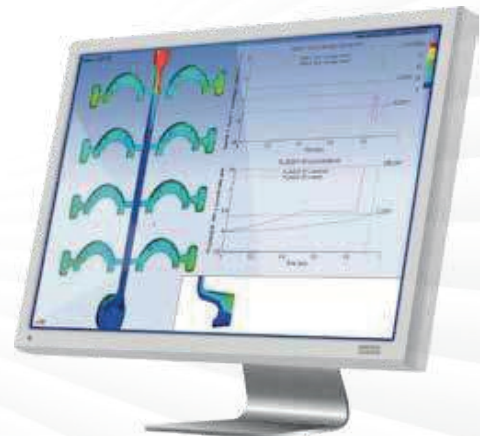

Las **bandas de freno** de **INDUSTRIAS JAPAN S.A** son el resultado de mas de 30 años de trabajo y mejora continua. Las zapatas son fabricadas en aleación de Aluminio bajo estándares japoneses, por proceso de inyección a presión (DIE CASTING TECHNOLOGY), que garantizan una alta resistencia mecánica.

El material de fricción, totalmente libre de asbesto, ha sido desarrollado con el apoyo de centros de investigación y desarrollo en Estados Unidos y Alemania, garantizando un desempeño seguro y estable en diferentes condiciones climáticas.

El coeficiente de fricción y el desgaste son controlados continuamente con **pruebas de laboratorio bajo norma JIS D4411** (Japan Industrial Standard) y SAE J661 (Automotive Engineering).



INDUSTRIAS JAPAN S.A.
Fabricantes de partes para motocicletas
Live safely



BANDAS DE FRENO Premium GG



JAPAN
Frenos de Alto Desempeño

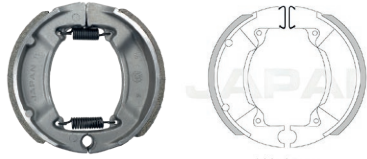

110x25mm

Cód:101011

Cód Original: 296-25330-00

No	MARCA	APLICACIONES	D	T
1	YAMAHA	CHAPPY	X	X
2	YAMAHA	V 80	X	X
3	YAMAHA	RX 100	X	X
4	YAMAHA	RX 115	X	X



130x28mm

Cód:101012

Cód Original: 437-25330-00

No	MARCA	APLICACIONES	D	T
1	AKT	NKD 125	X	X
2	YAMAHA	VW 100 / XT 350 / DT 175	X	X
3	YAMAHA	AG 100 / AG 200	X	X
4	VICTORY	BOLD 125	X	X



130x28mm

Cód:101013

Cód Original: 41048-003

No	MARCA	APLICACIONES	D	T
1	KAWASAKI	G7 100	X	X
2	KAWASAKI	KB 100	X	X
3	KAWASAKI	GTO 125	X	X
4	KAWASAKI	KB 125	X	X



110x30mm

Cód:101014

Cód Original: 41048-017

No	MARCA	APLICACIONES	D	T
1	BAJAJ	BOXER 100	X	X
2	BAJAJ	CT 100 S	X	X
3	BAJAJ	PLATINA 100	X	X
4	BAJAJ	PLATINA 125	X	X



110x25mm

Cód:101015

Cód Original: 43120-365-671

No	MARCA	APLICACIONES	D	T
1	AKT	FLEX 110 / SPECIAL X110	X	X
2	HONDA	NXR 125	X	X
3	HONDA	XL 125 / XL 185	X	X
4	KYMCO	ACTIV110/VISA R 110	X	X
5	HERO	ECO 100/ECO 125	X	X
6	VENTO	RAPID 125	X	X



100x 25mm

Cód:101016

Cód Original: 54410-02410

No	MARCA	APLICACIONES	D	T
1	SUZUKI	FZ 50	X	X
2				
3				
4				



110x30mm

Cód:101017

Cód Original: 54400-35880

No	MARCA	APLICACIONES	D	T
1	SUZUKI	AX 100	X	X
2	SUZUKI	FR 80 / FR 100	X	X
3	SUZUKI	AX 115	X	X
4	TVS	STAR 100	X	X



110x25mm

Cód:101018

Cód Original: 54410-43021

No	MARCA	APLICACIONES	D	T
1	SUZUKI	TS 125 Z	X	X
2				
3				
4				



80x17mm

Cód:101019

Cód Original: 2E9-25130-00

No	MARCA	APLICACIONES	D	T
1	HONDA	QR 50	X	X
2	YAMAHA	PW 50	X	X
3	YAMAHA	TOWNY PASSOLA MJ 50	X	X
4	YAMAHA	TTR 50	X	X



130x28mm

Cód:101172

Cód Original: N.A.

No	MARCA	APLICACIONES	D	T
1	YAMAHA	DT 175	X	X
2	YAMAHA	XT 250	X	X
3	YAMAHA	BWS 100	X	X
4	YAMAHA	RX 100 INDIA	X	X

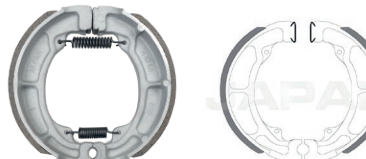

120x28mm

Cód:1010110

Cód Original: 41048-015

No	MARCA	APLICACIONES	D	T
1	KAWASAKI	KE 125	X	X
2	KAWASAKI	KOYOYE 175	X	X
3				



110x25mm

Cód:1010111

Cód Original: 22F-25330-00

No	MARCA	APLICACIONES	D	T
1	YAMAHA	DT 100 K	X	X
2	YAMAHA	RS 100	X	X
3	YAMAHA	AG 200	X	X
4				

BANDAS DE FRENO Premium GG



JAPAN
Frenos de Alto Desempeño



130x28mm

Cód:1010112

Cód Original: 54410-07002

No	MARCA	APLICACIONES	D	T
1	TVS	APACHE 160	X	X
2	SUZUKI	TS 100	X	X
3	SUZUKI	GS 125	X	X
4	SUZUKI	TS 185	X	X



110x25mm

Cód:1010113

Cód Original: 45120-096-651

No	MARCA	APLICACIONES	D	T
1	HONDA	CB 110 / WAVE 110	X	X
2	SUZUKI	AX 4	X	X
3	ITALIKA	VITALIA 125/AT 125 RT/VITALIA 150	X	X
4	ITALIKA	AT 110/D125 LT/CS 125/DT 125 DELIV	X	X



80x20mm

Cód:1010114

Cód Original: 54410-02312

No	MARCA	APLICACIONES	D	T
1	SUZUKI	FA 50	X	X
2	SUZUKI	LT 80	X	X
3				
4				

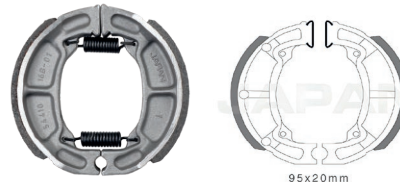

95x20mm

Cód:1010115

Cód Original: 54410-16B01

No	MARCA	APLICACIONES	D	T
1	SUZUKI	ADDRESS 60	X	X
2	SUZUKI	ZEPIA 50	X	X
3				
4				



150x24mm

Cód:1010116

Cód Original: 4144504

No	MARCA	APLICACIONES	D	T
1	BAJAJ	LEGEND 150	X	X
2	BAJAJ	PLUS 150	X	X
3	PIAGGIO VESPA	PX 150	X	X
4				

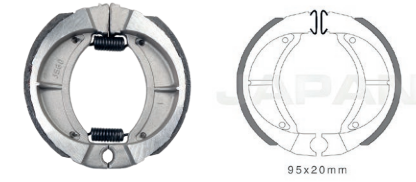

95x20mm

Cód:1010117

Cód Original: 451-25130-00

No	MARCA	APLICACIONES	D	T
1	YAMAHA	CY 50 JOG	X	X
2	YAMAHA	TT-R 80	X	X
3	YAMAHA	PASSOL 50	X	X
4				



110x25mm

Cód:1010118

Cód Original: 4BE-W2536-00

No	MARCA	APLICACIONES	D	T
1	YAMAHA	CHAPPY	X	X
2	YAMAHA	JOG 50	X	X
3	YAMAHA	TT-R 110 E	X	X
4	YAMAHA	AXIS 90	X	X



130x28mm

Cód:1010119

Cód Original: 3FA-W2536-00

No	MARCA	APLICACIONES	D	T
1	YAMAHA	DT 125	X	X
2	YAMAHA	DT 175	X	X
3	YAMAHA	KTZ 125	X	X
4	YAMAHA	YBR 125 G	X	X

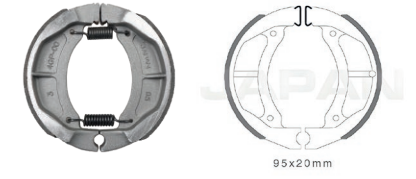

95x20mm

Cód:1010120

Cód Original: 27V-W2536-00

No	MARCA	APLICACIONES	D	T
1	YAMAHA	JOG 50	X	X
2	YAMAHA	PW 80	X	X
3	YAMAHA	TT-R 90	X	X
4	YAMAHA	TT-R 110 E	X	X

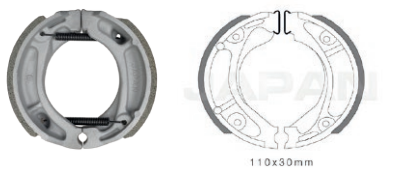

110x30mm

Cód:1010121

Cód Original: 43120-428-013

No	MARCA	APLICACIONES	D	T
1	AKT	TT 125 (07-13)	X	X
2	HONDA	XL 200	X	X
3	HONDA	XLR 125	X	X
4				



130x28mm

Cód:1010122

Cód Original: 43120-B06-000

No	MARCA	APLICACIONES	D	T
1	SYM	CROX 125	X	X
2	AKT	DYNAMIC 125 / DYNAMIC PRO CBS	X	X
3	POLARIS	OUTLAW 110 EFI	X	X
4	AKT	JET 4	X	X



130x30mm

Cód:1010123

Cód Original: 43120-362-000

No	MARCA	APLICACIONES	D	T
1	HONDA	GL 145	X	X
2	HONDA	XL 250	X	X
3	VICTORY	BOMBER 125	X	X
4	VICTORY	BOMBER 150	X	X

BANDAS DE FRENO Premium GG



JAPAN
Frenos de Alto Desempeño



130x25mm

Cód:1010124

Cód Original: 45125-KCC-900

No	MARCA	APLICACIONES	D	T
1	HERO	IGNITOR		X
2	HERO	ECO 150	X	X
3	HERO	DASH 125		X
4	HERO	HUNK 150		X



120x30mm

Cód:1010125

Cód Original: 64400-01850

No	MARCA	APLICACIONES	D	T
1	SUZUKI	TS 50 X	X	X
2	SUZUKI	TS 150 X		X
3	SUZUKI	TS 125 X		X



95x20mm

Cód:1010126

Cód Original: 06430-GE8-405

No	MARCA	APLICACIONES	D	T
1	HONDA	NH 50 LEAD		X
2	HONDA	NH 80 LEAD		X
3				
4				



150x24mm

Cód:1010127

Cód Original: 06-1501-01

No	MARCA	APLICACIONES	D	T
1	BAJAJ	LEGEND 150	X	X
2	BAJAJ	PLUS 150		X
3				
4				



95x20mm

Cód:1010128

Cód Original: 43120-GE1-671

No	MARCA	APLICACIONES	D	T
1	HONDA	DIO 50	X	X
2	HONDA	CRF 100 F		X
3	HONDA	XR 80 R	X	X
4	HONDA	CR 110 F	X	X



130x25mm

Cód:1010129

Cód Original: 06430-KGA-900

No	MARCA	APLICACIONES	D	T
1	HONDA	CBF 125 STUNNER		X
2	HONDA	CBF 150		X
3	HONDA	CBF 125 / STORM 125		X
4	HONDA	DIO 110 / NAVI	X	X



170x30mm

Cód:1010130

Cód Original: 22-1502-35

No	MARCA	APLICACIONES	D	T
1	BAJAJ	TORITO	X	X
2	TVS	KING TUK TUK	X	X
3	TVS	KING 45 200	X	X
4				

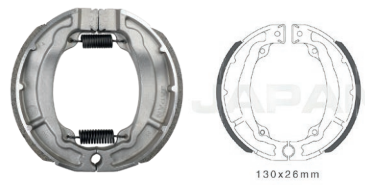

130x26mm

Cód:1010131

Cód Original: 06430-KRF-T00

No	MARCA	APLICACIONES	D	T
1	HONDA	CGL 125	X	X
2	KEENWAY	KW 125 F		X
3	AKT	RTX 150 (14-17)		X
4				



130x26mm

Cód:1010132

Cód Original: 30-1510-53

No	MARCA	APLICACIONES	D	T
1	BAJAJ	DISCOVER 150		X
2	BAJAJ	PULSAR 135 / NS 125		X
3	BAJAJ	PULSAR 180 / PULSAR 150 NEÓN		X
4	BAJAJ	BOXER 150 / 150 - X		X



120x25mm

Cód:1010133

Cód Original: 64400-09J00

No	MARCA	APLICACIONES	D	T
1	SUZUKI	AN 125		X
2	SUZUKI	ACCES 125		X
3	SUZUKI	LET'S 110	X	X
4	SUZUKI	BURGMAN 125		X



150x28mm

Cód:1010134

Cód Original: 5ML-XF533-00

No	MARCA	APLICACIONES	D	T
1	YAMAHA	BWS 125		X
2				
3				
4				



170x30mm

Cód:1010135

Cód Original: 24-1511-71

No	MARCA	APLICACIONES	D	T
1	BAJAJ	TORITO NEW		X
2	BAJAJ	RE 200 4S		X
3	BAJAJ	RE 205 D		X
4				

BANDAS DE FRENO Premium GG



JAPAN
Frenos de Alto Desempeño



130x28mm

Cód:1010136

Cód Original: 5YY-WF533-00

No	MARCA	APLICACIONES	D	T
1	YAMAHA	XTZ 125 / FINO	X	X
2	YAMAHA	SZ RR / LIBERO 125	X	X
3	YAMAHA	FZ 16 / FZ 16 2.0 / YBR 125 E / D / ESD	X	X
4	SUZUKI	DR 150	X	X

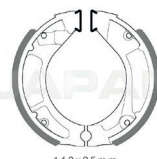

110x25mm

Cód:1010137

Cód Original: 06430-GCE-900

No	MARCA	APLICACIONES	D	T
1	HONDA	XR 125 L / XR 150 L / XR 190 L	X	X
2	HONDA	CB 110	X	X
3	HONDA	C 100 WAVE / WAVE 110 S	X	X
4	HONDA	C 100 BIZ	X	X

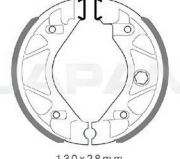

130x28mm

Cód:1010138

Cód Original: 5D9-F530K-00

No	MARCA	APLICACIONES	D	T
1	YAMAHA	YZZ 110	X	X
2	YAMAHA	CRYPTON F.I.	X	X
3	YAMAHA	XTZ 150	X	X
4	YAMAHA	YD 110 - 4 CRUX	X	X



130x25mm

Cód:1010139

Cód Original: 4312A-KUDU-C00

No	MARCA	APLICACIONES	D	T
1	KYMCO	AGILITY 125	X	X
2	KYMCO	AGILITY ALL NEW	X	X
3	KYMCO	FLY 125	X	X
4	KYMCO	SUPER 8 150	X	X



130x28mm

Cód:1010143

Cód Original: 54410-28G30-000

No	MARCA	APLICACIONES	D	T
1	SUZUKI	GN 125	X	X
2	SUZUKI	EN 125	X	X
3	SUZUKI	GIXXER 150 - VERSIÓN 1	X	X
4	SUZUKI	DR 200	X	X

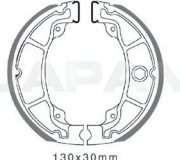

130x30mm

Cód:1010144

Cód Original: 070830004

No	MARCA	APLICACIONES	D	T
1	VICTORY	MACH 110 / NITRO 125	X	X
2	VICTORY	ONE 100 / ONE 100 ST	X	X
3	VICTORY	ONE 110 ST	X	X
4	VENTO	CYCLON 150	X	X

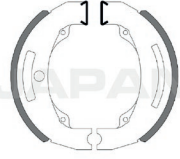

110 x 25 mm

Cód:1010145

Cód Original: 54400-23830-000

No	MARCA	APLICACIONES	D	T
1	SUZUKI	HAYATE 110	X	X
2	SUZUKI	HAYATE 115	X	X

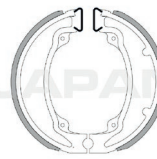

130 x 30 mm

Cód:1010146

Cód Original: 06430-GBJ-740

No	MARCA	APLICACIONES	D	T
1	AKT	CR 4 125	X	X
2	AKT	CR 5 180	X	X
3	VICTORY	MRX 125 PRO	X	X
4	VICTORY	MRX 125 TRAKU	X	X



Cód:1010148

Cód Original: K6320590

No	MARCA	APLICACIONES	D	T
1	TVS	HLX 150X	X	X
2	TVS	NTORQ - NTORQ FI - RAIDER 125 - F.I.	X	X
3	TVS	SPORT 100 ELS SP - KLS - 100 SBT	X	X
4	TVS	STRYKER INDO 125	X	X



- Bandas de freno *Premium*
- Pastillas **JAPAN** *Premium Organics*
- Pastillas **JAPAN** *Premium Semimetallics*
- Pastillas **JAPAN** *Racing*
- Pastillas **JAPAN** *COMPETITION PRO*
- Pastillas **JAPAN** *Bike*
- Maniguetas
- Bases de Espejo
- Conjunto Base + Manigueta
- Discos de Freno
- Reposapiés
- Ejes de Rueda
- Ejes de Cambio
- Varillas de Freno
- Cuñas
- Pedales de Encendido
- Pedales de Cambio
- Pedales de Freno
- Tornillos
- Resortes de Banda
- Otros Productos
- Rines **Murelli**

Industrias Japan S.A



INDUSTRIAS JAPAN S.A.
Fabricantes de partes para motocicletas

Live safely





CATÁLOGO DE PRODUCTOS

2026



www.industriasjapan.com



INDUSTRIAS JAPAN S.A.

Fabricantes de partes para motocicletas

Live safely

NUESTRA HISTORIA

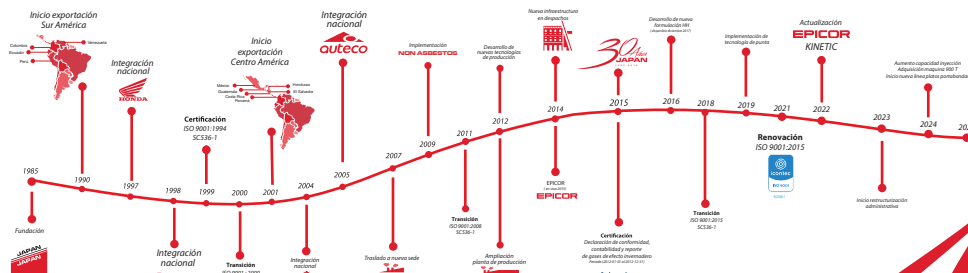

¿QUÉ ES EL COEFICIENTE DE FRICCIÓN?

Las características de fricción de las bandas y pastillas de freno, se miden por el comportamiento del coeficiente de fricción del material de desgaste en pruebas específicas de laboratorio. La norma americana SAE J866 ha clasificado los materiales en 7 niveles de acuerdo con rangos de fricción, los cuales se identifican con 2 letras, una representa el coeficiente de fricción normal o en frío y la segunda su comportamiento en caliente. En frenos, los niveles E y F corresponden a rangos de fricción corrientes y los niveles G y H, representan altos coeficientes de fricción.

Clasificación de niveles de fricción Según SAE J866 (CHASE)

COEFICIENTE DE FRICCIÓN	CÓDIGO DE FRICCIÓN		
	FRÍO	CALIENTE	
0.45 - 0.55 PREMIUM	G	G	JAPAN Premium Organics
0.45 - 0.55 PREMIUM	G	G	JAPAN Premium Pastillas
0.45 - 0.55 High Performance	HH/GG	HH/GG	JAPAN Racing
Mayor a 0.55 Alto Desempeño/ High Performance	H	H	JAPAN Competition Brake Pads



JAPAN Premium Organics

JAPAN Premium Pastillas

Coeficiente de fricción **GG**

Premium para motos de 80 cc. a 250 cc.



JAPAN Racing

Coeficiente de fricción **HH y GG**

Alto desempeño para motos de 300 cc. en adelante



Coeficiente de fricción **HH**

High Performance



*(HH y HH orientada solo para motos de carrera o ambientes de alta exigencia).

INDUSTRIAS JAPAN S.A fabrica los materiales de fricción de las bandas y pastillas con coeficientes **GG** para motocicletas del mercado tradicional y coeficiente **HH** para frenos en motocicletas de alto cilindraje.

CLASIFICACIÓN PASTILLAS JAPAN



Pastillas de freno **JAPAN**
Premium Organics



Calidad *Premium*

Motocicletas de trabajo con gran exigencia de frenado en movilidad de alto tráfico.

Tipo *Orgánico* a base de fibras minerales y orgánicas, elastómeros, partículas activadoras y reguladoras del coeficiente de fricción; y resinas aglomerantes.

Mayor coeficiente de fricción para una respuesta de frenado más rápida. Menor distancia de parada.



Coeficiente de fricción
 μ : 0.45 - 0.55



Pastillas de freno **JAPAN**
Premium Semimetallics



Calidad *Premium*

Motocicletas de calle y todoterreno con gran exigencia de frenado. Ideales en terrenos destapados y estilos de conducción más agresivos.

Tipo *Orgánico* a base de fibras minerales y fibras de acero.

Mayor coeficiente de fricción para una respuesta de frenado más rápida. Menor distancia de parada.



Coeficiente de fricción
 μ : 0.45 - 0.55



Pastillas de freno **JAPAN**
Racing



Freno
DELANTERO



Pastillas de freno **JAPAN**
Racing



Freno
TRASERO

Calidad High Performance

Motocicletas de alto cilindraje (> 250 cc), Con gran exigencia de frenado en diferentes estilos de conducción desde moderado hasta deportivo.

Compuesto: *Orgánico* a base de fibras minerales, polvos metálicos, elementos activadores y reguladores del coeficiente de fricción y resina aglomerante. Contiene partículas especiales y platina con recubrimiento en cobre para alta disipación de calor. Productos con alto coeficiente de fricción: Pastillas delanteras con nivel HH y traseras con nivel GG.



Coeficiente de fricción
Delanteras μ : \geq 0.55
Traseras μ : 0.45 - 0.55



JAPAN
Bike



Pastillas de freno **JAPAN**

COMPETITION PRO

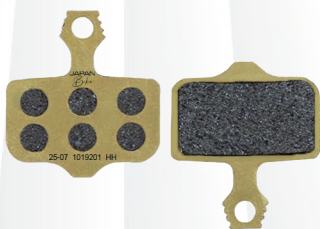

Pastillas de freno con un material de fricción de muy alto coeficiente (HH). La platina de respaldo incorpora un sistema de retención por grafilado que mejora la adherencia del compuesto.

Son productos totalmente libres de asbesto, compuestos por fibras minerales, fibras metálicas, partículas especiales para la alta disipación de calor, resina aglomerante, elementos activadores y reguladores del coeficiente de fricción. Por su naturaleza orgánica, son pastillas suaves que protegen los discos de freno contra el desgaste excesivo.

El nivel de fricción es HH, tanto en las pastillas delanteras como en las traseras, Clasificando estas pastillas como un producto High Performance.





PASTILLAS DE FRENO

Premium Organics

1

INDUSTRIAS JAPAN S.A.
Fabrica 5 tipos de pastillas de freno:

JAPAN
COMPETITION PRO

JAPAN
Racing

JAPAN
Premium Organics

JAPAN
Premium Semimetallics

JAPAN
Bike

2

El material de fricción, totalmente LIBRE DE ASBESTO, ha sido desarrollado con el apoyo de centros de investigación y desarrollo en Estados Unidos y Alemania.

3

Cumplen con las dimensiones requeridas para garantizar su ensamble y funcionamiento en la motocicleta.



Las pastillas de freno de **INDUSTRIAS JAPAN S.A.** son el resultado de más de 40 años de trabajo y mejora continua.

Son fabricadas por proceso de moldeo positivo garantizando la homogeneidad del producto en cuanto a su densidad, dureza y desgaste, proporcionando un desempeño seguro y estable en diferentes condiciones climáticas.

El coeficiente de fricción y el desgaste son controlados continuamente con pruebas de laboratorio bajo norma JIS D4411 (Japan Industrial Standard) y SAE J661 (Automotive Engineering).



INDUSTRIAS JAPAN S.A.
Fabricantes de partes para motocicletas
Live safely



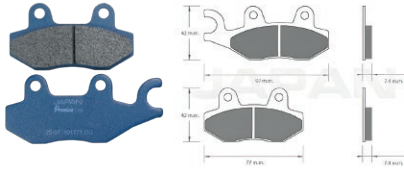

Cód:101771

Cód Original: 1S3-W0045-10

No	MARCA	APLICACIONES	D	T
1	KYMCO	AGILITY 125	X	
2	KAWASAKI	KLX 150		X
3	SUZUKI	EN 125 / GS 125	X	
4	YAMAHA	XTZ 125 / XTZ 250	X	

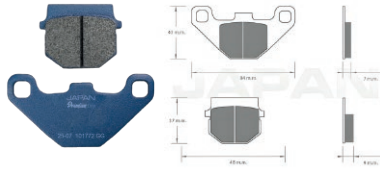

Cód:101772

Cód Original: 453036

No	MARCA	APLICACIONES	D	T
1	KAWASAKI	KMX 125 PRIMER MODELO	X	
2	SUZUKI	AN 100 SPACE		X
4				

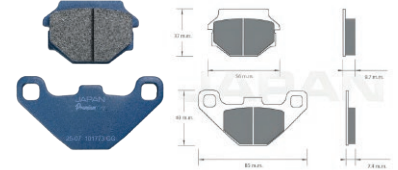

Cód:101773

Cód Original: 42385-94Y

No	MARCA	APLICACIONES	D	T
1	HAQJUE	VS 125	X	
2	KAWASAKI	KMX 125 PRIMER MODELO		X
3	KYMCO	UNI-K 110	X	
4	SUZUKI	TR 125	X	

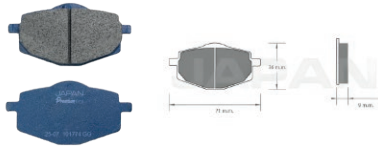

Cód:101774

Cód Original: 1UY-W0045-00

No	MARCA	APLICACIONES	D	T
1	YAMAHA	XT 350 / XT 500	X	
2	YAMAHA	DT 200		X
3	YAMAHA	SEROW 225	X	
4	YAMAHA	XT 600 E	X	

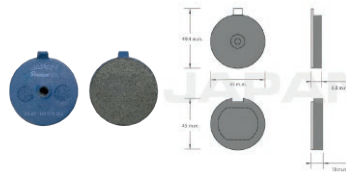

Cód:101775

Cód Original: 59300-39820

No	MARCA	APLICACIONES	D	T
1	AUTECO	FURAX 150	X	
2	VENTO	CROSSMAX 200	X	
3	SUZUKI	GP 125	X	
4	UM	DUAL SPORTS 125	X	
5				
6				

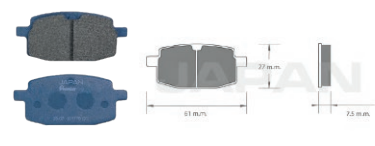

Cód:101776

Cód Original: 2NA-W0045-00

No	MARCA	APLICACIONES	D	T
1	YAMAHA	YW 100 BW'S 100	X	
2	YAMAHA	JOG 50	X	
3	YAMAHA	AXIS 90	X	
4				

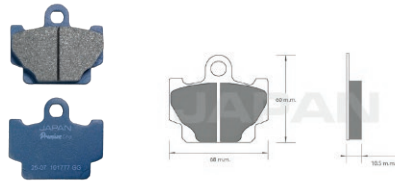

Cód:101777

Cód Original: 11H-W0045-00

No	MARCA	APLICACIONES	D	T
1	YAMAHA	RX 115 S	X	
2	YAMAHA	RX 125	X	
3	YAMAHA	RX 135	X	
4				

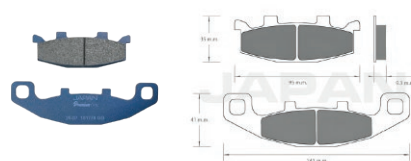

Cód:101778

Cód Original: 43082-1068

No	MARCA	APLICACIONES	D	T
1	KAWASAKI	GPZ 400	X	X
2	KAWASAKI	EX 500	X	
3	KAWASAKI	ZEPHYR 550	X	
4	SUZUKI	GS 500 (ANTES DEL '95)	X	

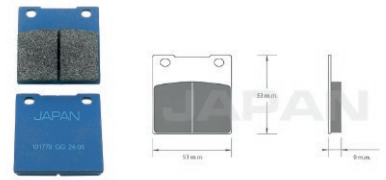

Cód:101779

Cód Original: 59100-16810

No	MARCA	APLICACIONES	D	T
1	SUZUKI	GS 500	X	
2	SUZUKI	KATANA 750	X	
3	SUZUKI	KATANA 600	X	
4	SUZUKI	GSXR 600 (97-03)	X	



Cód:1017710

Cód Original: 06455-GBZ-006

No	MARCA	APLICACIONES	D	T
1	KAWASAKI	KLX 150	X	
2	SUZUKI	DR 200	X	
3	POLARIS	OUTLAW 70 EH	X	
4	AKT	XM 180 / 200 / SM 200	X	

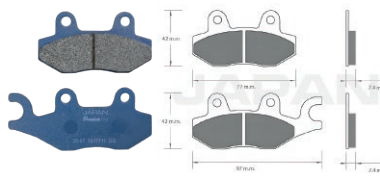

Cód:1017711

Cód Original: 06455-KR3-415

No	MARCA	APLICACIONES	D	T
1	KAWASAKI	MAGIC / CHEER / KAZE / VICTOR	X	X
2	SUZUKI	VIVA 115 F.D.	X	
3	HONDA	CBX250 TWISTER (2002-2009)	X	

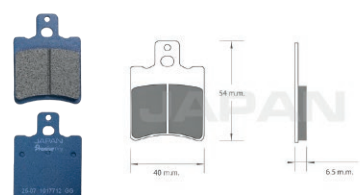

Cód:1017712

Cód Original: 21050-BN1-00000

No	MARCA	APLICACIONES	D	T
1	PIAGGIO	TYPHOON 50	X	
2	YAMAHA	YG 50 Z	X	
3				
4				

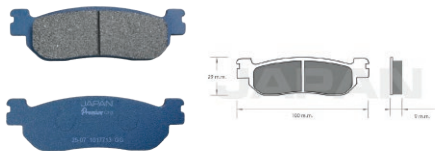

Cód:1017713

Cód Original: 10C-25806-00

No	MARCA	APLICACIONES	D	T
1	YAMAHA	DT 125 D	X	
2	YAMAHA	DT 175 DS	X	
3	YAMAHA	CRYPTON 110 ED	X	
4	YAMAHA	YBR 125 BRASIL	X	

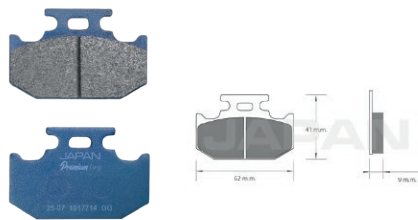

Cód:1017714

Cód Original: 3C5-25806-00

No	MARCA	APLICACIONES	D	T
1	YAMAHA	CBR 250 R (11-17)	X	
2	YAMAHA	V STROM 250	X	
3	YAMAHA	CB 500 X / NC 750	X	
4				

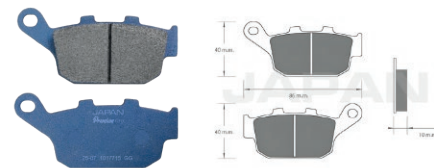

Cód:1017715

Cód Original: 06435-K64-N01

No	MARCA	APLICACIONES	D	T
1	HONDA	CBR 250 R (11-17)	X	
2	SUZUKI	INAZUMA 250	X	
3	SUZUKI	V STROM 250	X	
4	HONDA	CB 500 X / NC 750	X	

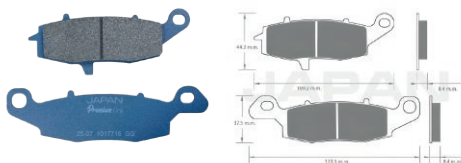

Cód:1017716

Cód Original: 43082-0010

No	MARCA	APLICACIONES	D	T
1	KAWASAKI	ER 6N	X	
2	SUZUKI	GLADIUS 650 / GSF BANDIT 650	X	
3	SUZUKI	SFV 650 GLADIUS / GSR 750	X	
4	SUZUKI	V STROM 650 CLASSIC / 1000	X	

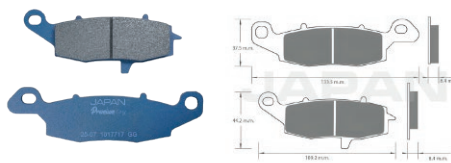

Cód:1017717

Cód Original: 43080-1187

No	MARCA	APLICACIONES	D	T
1	KAWASAKI	ER 6N	X	
2	SUZUKI	GLADIUS 650 / GSF BANDIT 650	X	
3	SUZUKI	SFV 650 GLADIUS / GSR 750	X	
4	SUZUKI	V STROM 650 CLASSIC / 1000	X	
5				
6				

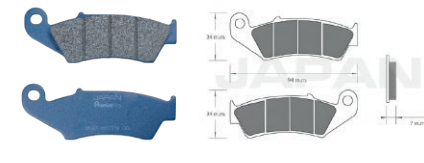

Cód:1017719

Cód Original: 06455-GZ8-405

No	MARCA	APLICACIONES	D	T
1	HONDA	XR 125 L / XR 150 L	X	
2	HONDA	XR 190 L / XR 190 CT	X	
3	HONDA	TORNADO 250	X	
4	HONDA	XL 200 / XL 250	X	

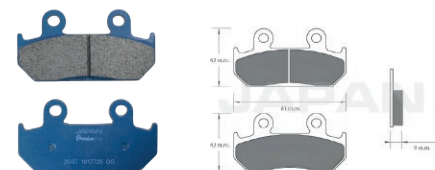

Cód:1017720

Cód Original: 45105-KT7-751

No	MARCA	APLICACIONES	D	T
1	HONDA	CB 450	X	
2	HONDA	CBR 600 MOD. ANTIGUO	X	
3				
4				

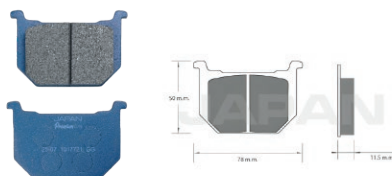

Cód:1017721

Cód Original: 59130-45230

No	MARCA	APLICACIONES	D	T
1	SUZUKI	GN 250 J	X	
2	SUZUKI	GS 250 (91-94)	X	
3				
4				

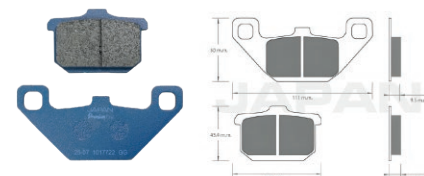

Cód:1017722

Cód Original: 43082-1029

No	MARCA	APLICACIONES	D	T
1	KAWASAKI	VN 400	X	
2	KAWASAKI	VN 800	X	
3	KAWASAKI	VN 1500	X	
4				

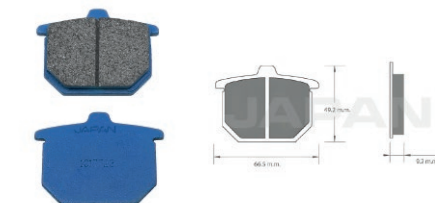

Cód:1017723

Cód Original: 45105-410-004

No	MARCA	APLICACIONES	D	T
1	HONDA	CB 750 F	X	
2	HONDA	CBX 100	X	
3	HONDA	CB 250 N	X	
4	HONDA	GL 400 / CX 500	X	

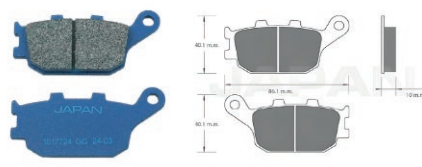

Cód:1017724

Cód Original: 06435-MEE-006

No	MARCA	APLICACIONES	D	T
1	HONDA	CBF 500 / CBF 600	X	
2	HONDA	CBR 600 F2	X	
3	HONDA	V STROM 800	X	

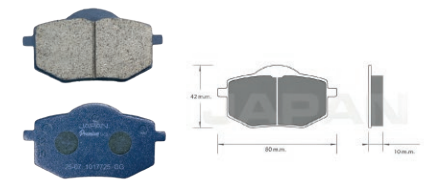

Cód:1017725

Cód Original: 2GV-W0045-00

No	MARCA	APLICACIONES	D	T
1	YAMAHA	XV 535 VIRAGO	X	
2				
3				
4				

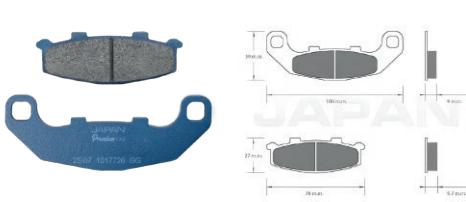

Cód:1017726

Cód Original: 43082-1075

No	MARCA	APLICACIONES	D	T
1	KAWASAKI	ZEPHYR 550	X	X
2	KAWASAKI	GPZ 400	X	
3	KAWASAKI	EX 250 F	X	X
4				

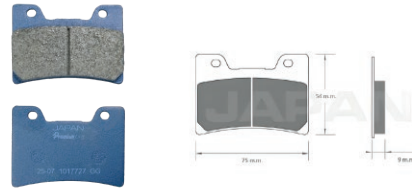

Cód:1017727

Cód Original: 3GM-W0045-00

No	MARCA	APLICACIONES	D	T
1	YAMAHA	FZR 600	X	X
2	YAMAHA	V MAX 1200	X	
3	YAMAHA	RD 250	X	X
4	YAMAHA	FZR 1000	X	X

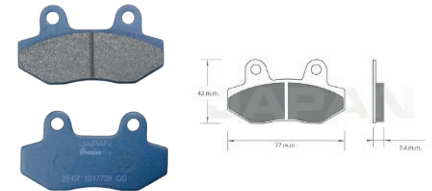

Cód:1017728

Cód Original: 06435-K64-N01

No	MARCA	APLICACIONES	D	T
1	AKT	NKD / NKDR 125 / AK 110 S	X	X
2	BERA M.	BR 150 LEÓN / BR 200	X	X
3	FRATELLI	FTR 125 / SFR 125 / SFS 125	X	X
4	VICTORY	LIFE / NEW LIFE / VENOM 14	X	X

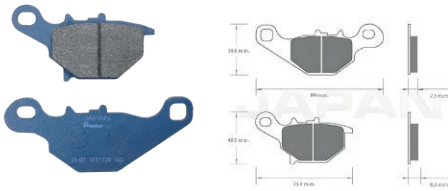

Cód:1017729

Cód Original: 43082-S001

No	MARCA	APLICACIONES	D	T
1	SUZUKI	ADDRESS 110	X	X
2	SUZUKI	ADDRESS 125 F.L.	X	
3	SUZUKI	ADDRESS NM 113 / NZ 113	X	X
4	KAWASAKI	KMX 125 ÚLTIMO MODELO	X	X

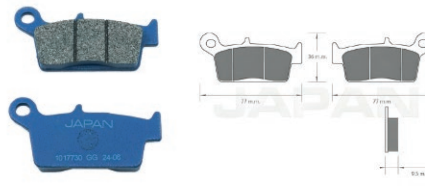

Cód:1017730

Cód Original: 06435-KCZ-000

No	MARCA	APLICACIONES	D	T
1	HONDA	XRE 300 PRIMER MODELO	X	X
2	HONDA	XR 250 R	X	X
3	HONDA	XR 600 / XR 650 L	X	X
4	KAWASAKI	KLX 250 / KLX 300	X	X
5	SUZUKI	DR Z 400	X	X
6				



Cód:1017731

Cód Original: 1D7-W0045-00

No	MARCA	APLICACIONES	D	T
1	YAMAHA	YZF 600	X	X
2	YAMAHA	MT 07	X	X
3	YAMAHA	TRACER 900	X	X
4	YAMAHA	YZF R1 / YZF R6	X	X

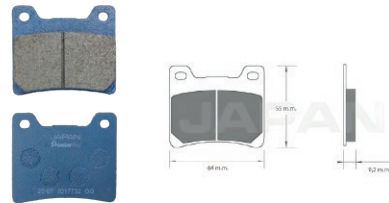

Cód:1017732

Cód Original: 1FK-W0045-00

No	MARCA	APLICACIONES	D	T
1	YAMAHA	FZ 600	X	X
2	YAMAHA	VIRAGO 750 / VIRAGO 1100	X	X
3	YAMAHA	V STAR 1100 / V MAX 1200	X	X
4				

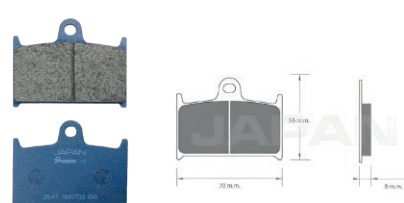

Cód:1017733

Cód Original: 2020073-T0301

No	MARCA	APLICACIONES	D	T
1	TRIUMPH	TIGER EXPLORER	X	X
2	TRIUMPH	THUNDERBIRD COMANDER	X	X
3				
4				

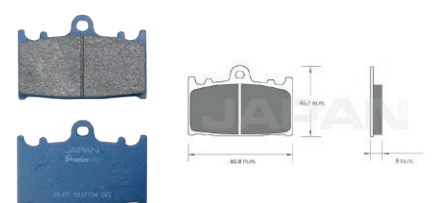

Cód:1017734

Cód Original: N/A

No	MARCA	APLICACIONES	D	T
1	SUZUKI	SV 650 ABS	X	X
2	KAWASAKI	VERSYS 1000	X	X
3	SUZUKI	GSF BANDIT 650 SA/1250 F ABS	X	X
4	KAWASAKI	VULCAN VAQUERO/VOYAGER 1700	X	X

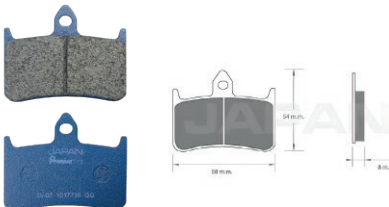

Cód:1017735

Cód Original: 06455-KEA-006

No	MARCA	APLICACIONES	D	T
1	HONDA	CBR 600 / CBR 900 RR	X	X
2	HONDA	CBR 1000	X	X
3	HONDA	CB 900 HORNET	X	X
4	HONDA	VTR 1000 F	X	X

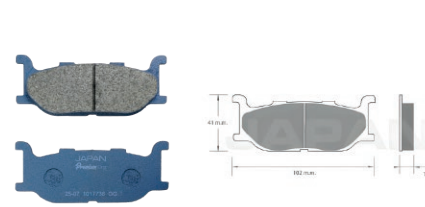

Cód:1017736

Cód Original: 3LP-25805-00

No	MARCA	APLICACIONES	D	T
1	YAMAHA	XV 535	X	X
2	YAMAHA	V STAR 650	X	X
3	YAMAHA	ROYAL STAR 1300	X	X

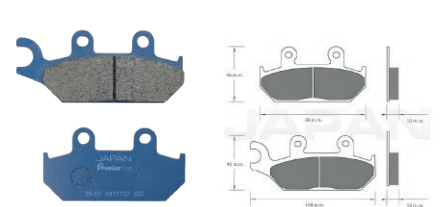

Cód:1017737

Cód Original: 1XD-25805-10

No	MARCA	APLICACIONES	D	T
1	YAMAHA	XT 600	X	X
2	YAMAHA	TENERE 750	X	X
3				
4				



PASTILLAS DE FRENO

Premium Organics



JAPAN

Frenos de Alto Desempeño



Cód:1017738

Cód Original: 252-0002A

No	MARCA	APLICACIONES	D	T
1	HUSQVARNA	HUSKY 50	X	
2	SUZUKI	DR 50	X	
3	KTM	SX 60	X	
4				

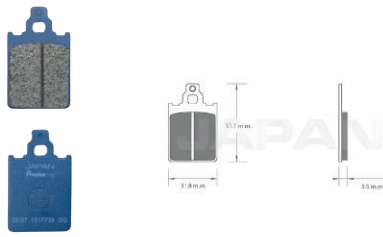

Cód:1017739

Cód Original: 494762

No	MARCA	APLICACIONES	D	T
1	PIAGGIO	PX 150 VESPA	X	
2				
3				
4				

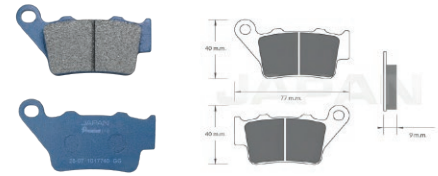

Cód:1017740

Cód Original: 06435-MAK-003

No	MARCA	APLICACIONES	D	T
1	SUZUKI	GIXXER 250/ 150 F.I./ 150 F.I. SF	X	X
2	BAJAJ	PULSAR NS 200 / RS 200	X	X
3	KTM	DUKE 250 / 390	X	X
4	CF MOTO	250 NK	X	X

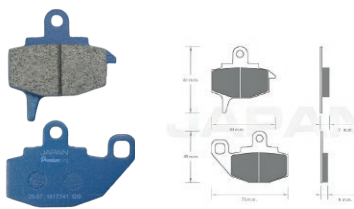

Cód:1017741

Cód Original: 43082-1072

No	MARCA	APLICACIONES	D	T
1	KAWASAKI	KLR 650 (1988-1995)	X	
2	KAWASAKI	KX 500	X	
3				
4				



Cód:1017742

Cód Original: 06455-GBY-910

No	MARCA	APLICACIONES	D	T
1	APRILIA	MOJITO 125	X	
2	PIAGGIO VESPA	ZIP 50 SP	X	
3				
4				
5				
6				

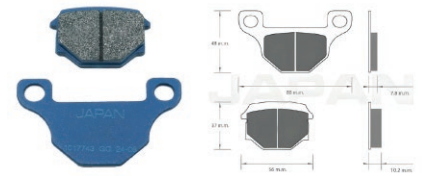

Cód:1017743

Cód Original: 59300-29820

No	MARCA	APLICACIONES	D	T
1	SUZUKI	FZ GN 125 H / F	X	
2	FRATELLI	FT 125	X	
3	VENTO	THRILLER 210	X	
4	UM	MAGNETIC 125	X	

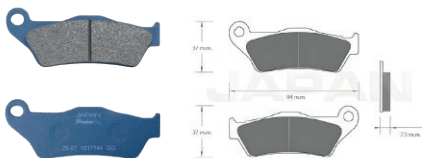

Cód:1017744

Cód Original: 000-306-546-250

No	MARCA	APLICACIONES	D	T
1	BAJAJ	PULSAR 180 / 135 LS	X	
2	BAJAJ	NS 125 / DISCOVER 125 ST	X	
3	YAMAHA	R 15 (22-24)	X	
4	YAMAHA	FZ 16 / FZ-S / FZ 25 / FZ 3.0	X	

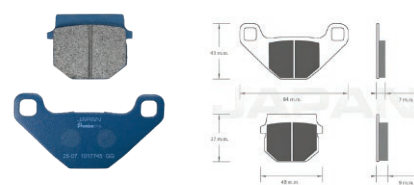

Cód:1017745

Cód Original: N/A

No	MARCA	APLICACIONES	D	T
1	VENTO	ZIP 50 (02-04)	X	
2				
3				
4				

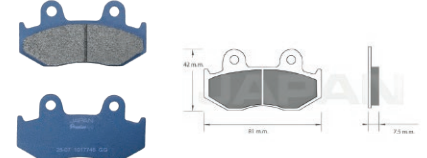

Cód:1017746

Cód Original: 06455-GCC-930

No	MARCA	APLICACIONES	D	T
1	HONDA	XLR 250	X	
2				
3				
4				

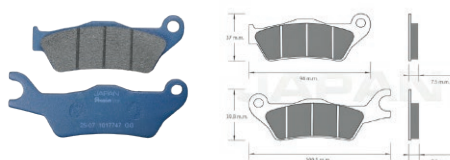

Cód:1017747

Cód Original: 06455-KCC-841

No	MARCA	APLICACIONES	D	T
1	HONDA	CBF 125 STUNNER	X	
2	HONDA	CBF 150 UNICORN	X	
3	HONDA	CB 110 DLX	X	
4				

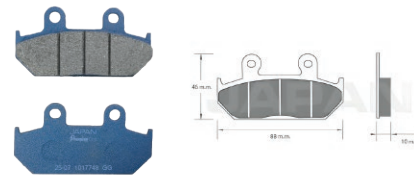

Cód:1017748

Cód Original: 06445-MS8-405

No	MARCA	APLICACIONES	D	T
1	HONDA	NV 400 STEED	X	
2	HONDA	CBR 600 F2 / CBR 1000	X	
3	HONDA	VRF 750	X	

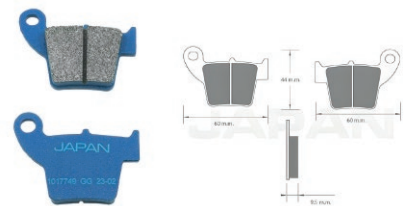

Cód:1017749

Cód Original: 06435-KRN-711

No	MARCA	APLICACIONES	D	T
1	HONDA	CRF 150 RB	X	
2	HONDA	CR 250	X	
3	HONDA	CRF 250 RC	X	
4	HONDA	CRE 450 F	X	

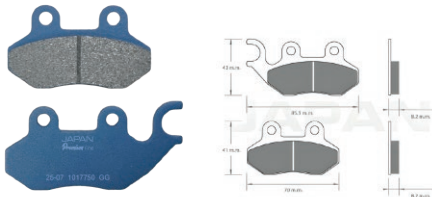

Cód:1017750

Cód Original: 45105-G02-000

No	MARCA	APLICACIONES	D	T
1	AKT	DYNAMIC K 125	X	
2	AKT	DYNAMIC KLASSIC 125	X	
3	AKT	JET 14 EVO F.I.	X	
4	SYM	CROX 125 / 150 / 180 F.I.	X	

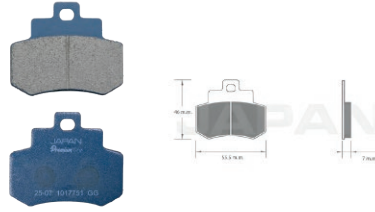

Cód:1017751

Cód Original: 43105-KKC4-306

No	MARCA	APLICACIONES	D	T
1	KYMCO	GRAND DINK 250		X
2				
3				
4				



Cód:1017752

Cód Original: 156924

No	MARCA	APLICACIONES	D	T
1	KYMCO	GRAND DINK 250		X
2	SYM	JOYMAX 125		X
3	SYM	JOYMAX 250 i		X
4	SYM	JOYMAX 300 i		X

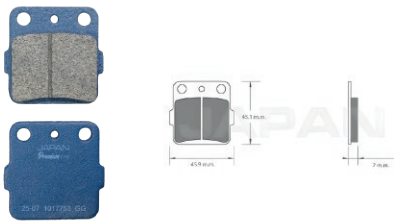

Cód:1017753

Cód Original: 06435-HA5-405

No	MARCA	APLICACIONES	D	T
1	HONDA	TRX 250	X	
2	SUZUKI	DR 200 - X	X	
3	HONDA	FOURTRAX	X	
4	YAMAHA	ATV YFS 200	X	

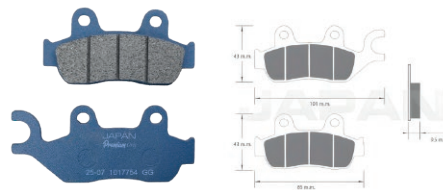

Cód:1017754

Cód Original: 06455-2G2-A20

No	MARCA	APLICACIONES	D	T
1	HONDA	CB 125 E	X	
2	HONDA	CB 125 F TWISTER	X	
3	HONDA	CGL 125	X	
4	HONDA	E STORM 125	X	
5	HONDA	CB 190 R	X	
6				

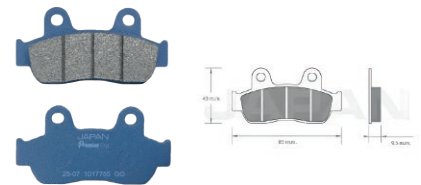

Cód:1017755

Cód Original: 06455-K8W-880

No	MARCA	APLICACIONES	D	T
1	HONDA	ELITE 125	X	
2	HONDA	ELITE 125 F.I.	X	
3				
4				

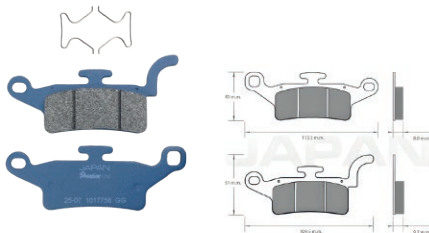

Cód:1017756

Cód Original: 52S-F5811-00

No	MARCA	APLICACIONES	D	T
1	YAMAHA	YW 125 BW'S (08-14)	X	
2				
3				
4				

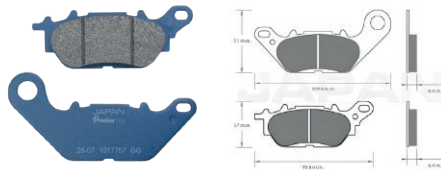

Cód:1017757

Cód Original: ZDP-F582W-00

No	MARCA	APLICACIONES	D	T
1	YAMAHA	CRYPTON 115 F.I.	X	
2	YAMAHA	NMAX 150	X	
3	YAMAHA	YBR 125 ESD / YBRZ 125	X	
4	YAMAHA	R 15 V1 - V2	X	

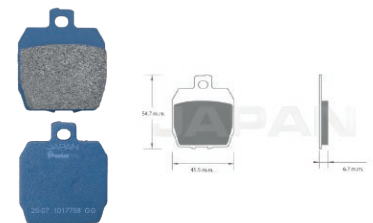

Cód:1017758

Cód Original: DK-1510-38

No	MARCA	APLICACIONES	D	T
1	BAJAJ	PULSAR 220 F		X
2				
3				
4				

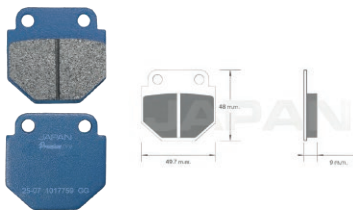

Cód:1017759

Cód Original: 4433D-197

No	MARCA	APLICACIONES	D	T
1	HONDA	CL 125	X	
2	JIALING	GOLD 135	X	
3				
4				

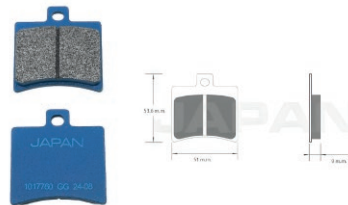

Cód:1017760

Cód Original: 119-486-00

No	MARCA	APLICACIONES	D	T
1	KEEWAY	RVK 125	X	
2	KEEWAY	TX 200	X	
3	AUTECO	VICTORY BLACK 171	X	

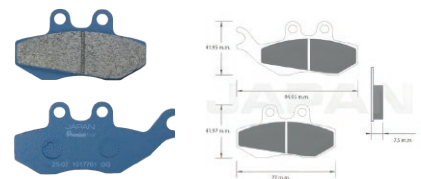

Cód:1017761

Cód Original: 119-493-00

No	MARCA	APLICACIONES	D	T
1	KEEWAY	TX 200	X	
2	KEEWAY	TX 200 EMPIRE	X	
3				
4				



PASTILLAS DE FRENO

Premium Organics



JAPAN

Frenos de Alto Desempeño

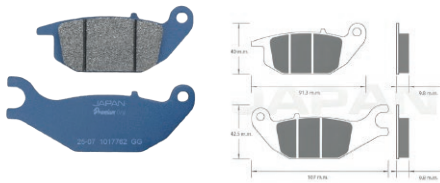

Cód:1017762

Cód Original: 06435-K0F-T01

No	MARCA	APLICACIONES	D	T
1	CF MOTO	PAPIO 125	X	X
2	HERO	THRILLER 150 PRO	X	X
3	HERO	HUNK 150 (14-17)	X	X
4	YAMAHA	R 15 V1 - V2	X	X

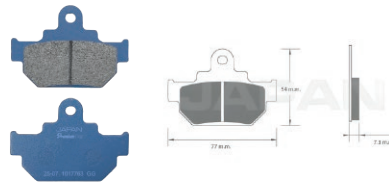

Cód:1017763

Cód Original: 59100-26820

No	MARCA	APLICACIONES	D	T
1	SUZUKI	SAVAGE 650	X	X
2	SUZUKI	MARAUJER 250	X	X
3				
4				

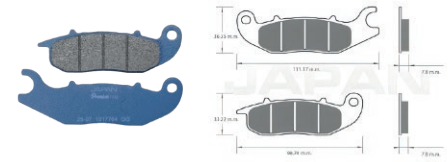

Cód:1017764

Cód Original: 0000-640-7210

No	MARCA	APLICACIONES	D	T
1	AUTEO VICTORY	SWITCH 150	X	X
2	HONDA	CB 150 INVICTA	X	X
3	HONDA	X-BLADE 160	X	X
4	HONDA	CB 160 F STD	X	X

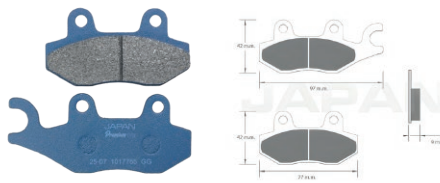

Cód:1017765

Cód Original: 06455-GCR-006

No	MARCA	APLICACIONES	D	T
1	AKT	CR 4 125 / CR 4 125 SE UNISHOCK	X	X
2	AKT	CR 5 200	X	X
3	BENELLI	TNT 135	X	X
4	BENELLI	180 S / TNT 150 / TNT 25	X	X

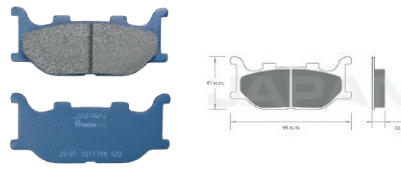

Cód:1017766

Cód Original: 1B7-25805-00

No	MARCA	APLICACIONES	D	T
1	YAMAHA	V STAR 250	X	X
2	YAMAHA	VIRAGO 250	X	X
3				
4				

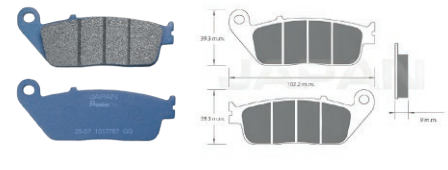

Cód:1017767

Cód Original: 06435-MBY-671

No	MARCA	APLICACIONES	D	T
1	HAQJUE	NK 150	X	X
2	HONDA	CBR 250 R MADE IN THAILAND	X	X
3	KAWASAKI	VERSYS 250	X	X
4	SUZUKI	V STROM 250	X	X

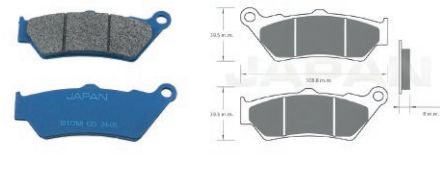

Cód:1017768

Cód Original: 000-306-546-260

No	MARCA	APLICACIONES	D	T
1	HONDA	CBR 250 R (BYBRE)	X	X
2	YAMAHA	XT 660 R	X	X
3	BMW	R 1250 GS	X	X
4	BMW	K 1600 GTL	X	X

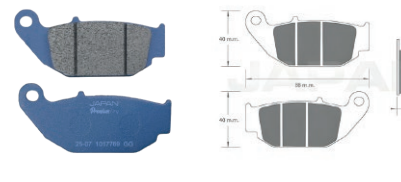

Cód:1017769

Cód Original: 06435-K26-901

No	MARCA	APLICACIONES	D	T
1	HONDA	CB INVICTA / CB 190 R	X	X
2	HERO	HUNK 190R / X-PULSE 200	X	X
3	SUZUKI	GIXXER SF/GSXR 150/GSXS 150	X	X
4				

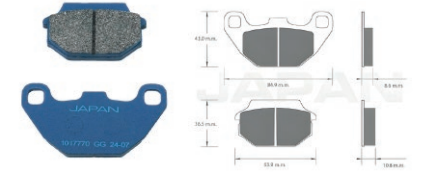

Cód:1017770

Cód Original: 3303-446

No	MARCA	APLICACIONES	D	T
1	KYMCO	AGILITY 150	X	X
2	KYMCO	AGILITY CITY	X	X
3	KYMCO	FLY 150	X	X
4	KYMCO	SUPER 8 150	X	X

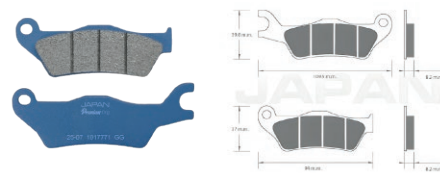

Cód:1017771

Cód Original: 59301-30810-00

No	MARCA	APLICACIONES	D	T
1	APRILIA	SR MOTARD 160 / SKR 160	X	X
2	HERO	XOOM 110 / 160	X	X
3	PIAGGIO VESPA	VXL 150 (23-24)	X	X
4	PIAGGIO VESPA	GTV 300	X	X

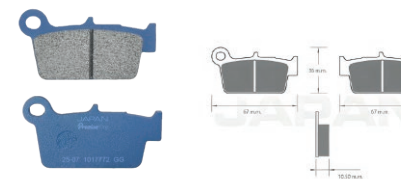

Cód:1017772

Cód Original: 1C3-W0046-00

No	MARCA	APLICACIONES	D	T
1	YAMAHA	YZ 125	X	X
2	SUZUKI	RMZ 250	X	X
3	YAMAHA	WR 250 F	X	X
4				

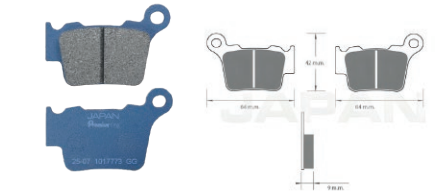

Cód:1017773

Cód Original: 54813090000

No	MARCA	APLICACIONES	D	T
1	KTM	EXC 250 / SX 250 / SXF 250	X	X
2	KTM	EXC 300 / SXF 450	X	X
3	KTM	EXC 350 / EXC 300 TPI	X	X
4	HUSQVARNA	TE 300I / TX 300I / TE 250I / FS450	X	X



PASTILLAS DE FRENO

Premium Organics



JAPAN

Frenos de Alto Desempeño

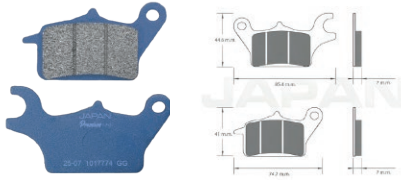

Cód:1017774

Cód Original: 59100B41HA0N000

No	MARCA	APLICACIONES	D	T
1	HONDA	WAVE 110 S	X	
2	YAMAHA	YZZ 110 / SZ 15 RR		X
3	SUZUKI	VIVA R 115	X	
4	VENTO	CROSSMAX PRO 250 / GTS 300		X

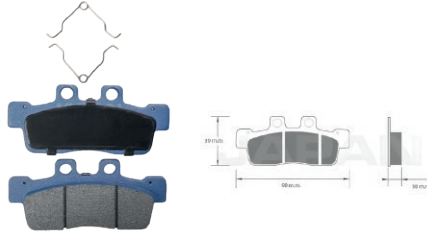

Cód:1017775

Cód Original: 17C-W0045-00

No	MARCA	APLICACIONES	D	T
1	YAMAHA	YW 125 X BW'S	X	
2				
3				
4				

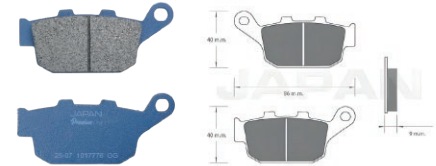

Cód:1017776

Cód Original: 53013-J042-0000

No	MARCA	APLICACIONES	D	T
1	AKT	CR 4 200	X	
2	VENTO	TORNADO 250 / STORM 250		X
3	ZONTES	ZT 155 U / LJ 200 SPORT	X	
4	VICTORY	NITRO 151 R		X

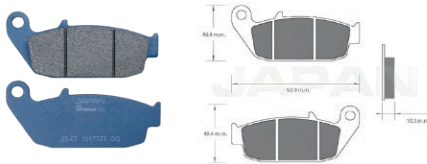

Cód:1017777

Cód Original: N9322240

No	MARCA	APLICACIONES	D	T
1	AKT	TT 200 DS / TT-R 180	X	
2	AKT	TT-X 200 / VOGUE 300 DS		X
3	TVS	APACHE 180	X	
4	TVS	APACHE 160 4V / APACHE 200		X

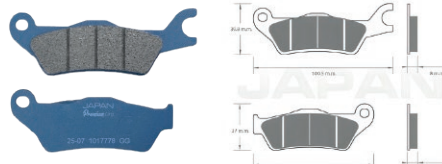

Cód:1017778

Cód Original: 06455KCC841

No	MARCA	APLICACIONES	D	T
1	HERO	IGNITOR 125	X	
2	HERO	HUNK 160 4V		X
3	HERO	THRILLER 150 PRO	X	
4	HERO	GLAMOUR 125	X	
5	HERO	HUNK 150	X	
6				

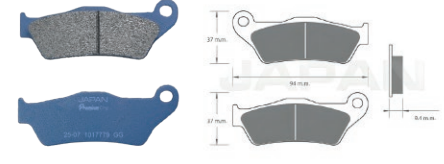

Cód:1017779

Cód Original: JL131832

No	MARCA	APLICACIONES	D	T
1	BAIAJ	NS 200	X	
2	BAIAJ	N 160		X
3	BAIAJ	N 250	X	
4	BAIAJ	RS 200		X

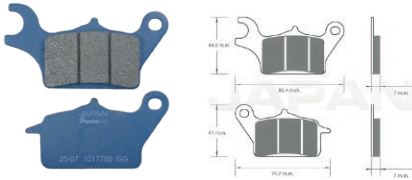

Cód:1017780

Cód Original: 06455-KVB-911

No	MARCA	APLICACIONES	D	T
1	HONDA	CLICK 125	X	
2	SUZUKI	BURGMAN 125		X
3	SUZUKI	ACCESS 125	X	
4	SUZUKI	AVENIS 125	X	

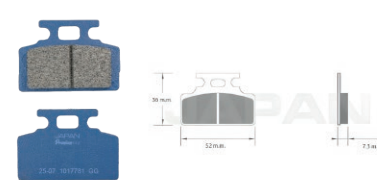

Cód:1017781

Cód Original: 43105-NF5-611

No	MARCA	APLICACIONES	D	T
1	ELECTRIKA	KEIKO 500	X	
2				
3				
4				

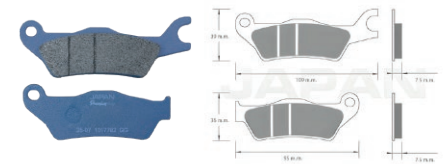

Cód:1017782

Cód Original: 06451-KZZ-901

No	MARCA	APLICACIONES	D	T
1	SUZUKI	GIXXR 150 / GIXXR 250 SF	X	
2	SUZUKI	GSSR 150		X
3	SUZUKI	GSSS 150	X	
4	SUZUKI	INTRUDER 150		X

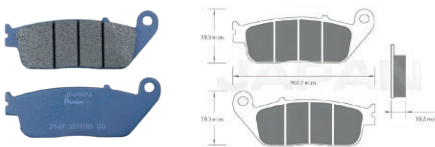

Cód:1017785

Cód Original: 06435-MBY-671

No	MARCA	APLICACIONES	D	T
1	YAMAHA	YW 125 BW'S F.I.	X	
2	SUZUKI	DR 150		X
3	SUZUKI	GZ 150 F.I.	X	
4	KYMCO	XCITING R 500		X

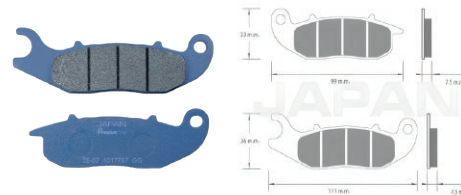

Cód:1017787

Cód Original: 06451-KZZ-901

No	MARCA	APLICACIONES	D	T
1	APRILIA	SR GT 200	X	
2	HONDA	CRF 250 RALLY	X	
3	VENTO	SCREAMER 250	X	

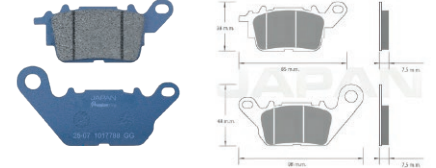

Cód:1017788

Cód Original: 2BM-F5805-00

No	MARCA	APLICACIONES	D	T
1	YAMAHA	CRYPTON 115 F.I.	X	
2	YAMAHA	N MAX 150		X
3	YAMAHA	AEROX 155	X	
4				

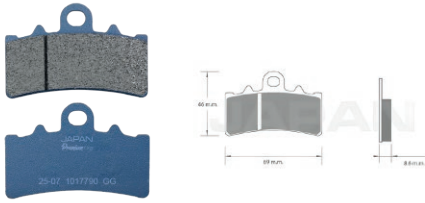

Cód:1017790

Cód Original: 4965005

No	MARCA	APLICACIONES	D	T
1	BAJAJ	DOMINAR 250	X	
2	KTM	DUKE 200 / RC 200 / DUKE 250	X	
3	BMW	G 310 GS	X	
4	BMW	CE 04 ELECTRIC	X	



Cód:1017793

Cód Original: 1C003307

No	MARCA	APLICACIONES	D	T
1	AKT	JET 14 (SYM) / DYNAMIC RX	X	
2	AKT	JET 5	X	
3	PIAGGIO VESPA	LX 125 / VXL 125	X	
4	SYM	CROX 150 / 180 / JET 14	X	

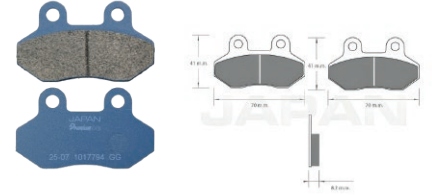

Cód:1017794

Cód Original: 530131853C200

No	MARCA	APLICACIONES	D	T
1	GENESIS	XM 200 Z	X	
2				
3				
4				

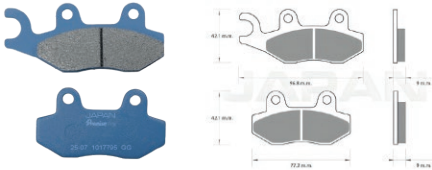

Cód:1017795

Cód Original: 45105-IDC8-305

No	MARCA	APLICACIONES	D	T
1	AKT	TT 200 DS / TT R 180 / TT X 180	X	
2	AKT	TT-X 200 / TT-R 125 NS	X	
3	AKT	TT 250 DUAL SPORT	X	
4	FRATELLI	XE 125 / SFX 160	X	

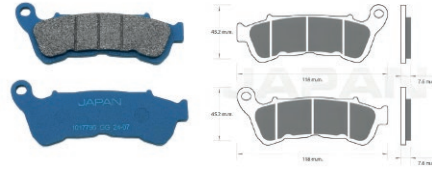

Cód:1017796

Cód Original: 06455-K04-701

No	MARCA	APLICACIONES	D	T
1	HONDA	CB 160 F DLX	X	
2	HONDA	FORZA 250	X	
3	HONDA	FORZA 300	X	
4				
5				
6				

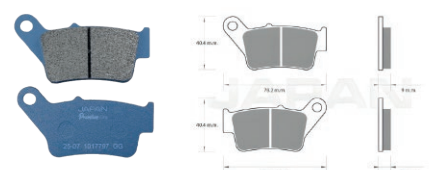

Cód:1017797

Cód Original: 36DH4174

No	MARCA	APLICACIONES	D	T
1	BAJAJ	PULSAR NS 160 / ABS	X	
2	BAJAJ	PULSAR P 150	X	
3	BAJAJ	N 160 / N 250	X	
4	BAJAJ	PULSAR NEON 180	X	

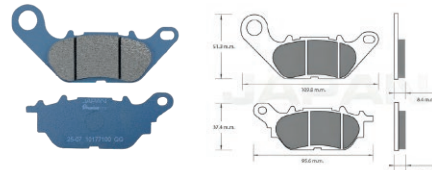

Cód:10177100

Cód Original: K6321900

No	MARCA	APLICACIONES	D	T
1	TVS	DAZZ 110	X	
2	TVS	NEO NX 110	X	
3	TVS	NTORQ	X	
4	TVS	NTORQ.F.I.	X	

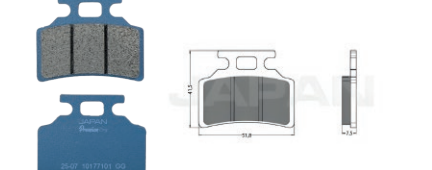

Cód:10177101

Cód Original: VC06070007

No	MARCA	APLICACIONES	D	T
1	VENTO	ATOM 150	X	
2	VENTO	ATOM 170	X	
3	VENTO	ATOM 170 2.0	X	
4				

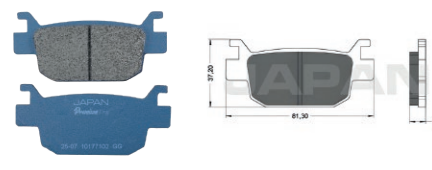

Cód:10177102

Cód Original: 06435-K01-901

No	MARCA	APLICACIONES	D	T
1	BENELLI	302 R / 302 S	X	
2	BENELLI	TRK 251 / TRK 251 ARENA	X	
3	HONDA	X ADV 350	X	
4	HONDA	PCX 160 ABS	X	



Cód:10177103

Cód Original: 45120P100000

No	MARCA	APLICACIONES	D	T
1	BENELLI	TRK 125 / TNT 150 I	X	
2	BENELLI	TRK 251 / TRK 251 ARENA	X	
3	BENELLI	302 R / 302 S	X	
4	BENELLI	TNT 25 N	X	

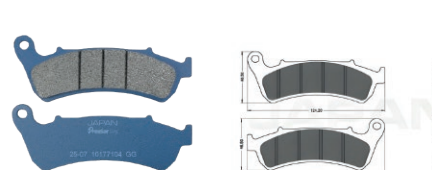

Cód:10177104

Cód Original: 59300HJ2Y00H000

No	MARCA	APLICACIONES	D	T
1	HAOJUE	DR 160 S	X	
2				
3				

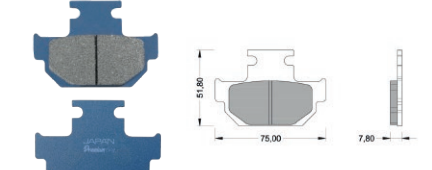

Cód:10177105

Cód Original: 251-0094A

No	MARCA	APLICACIONES	D	T
1	UM	RENEGADE 200	X	
2				
3				
4				



Cód:10177106

Cód Original: 47259-KX00001-0001

No	MARCA	APLICACIONES	D	T
1	VICTORY	VENOM 250		X
2	VICTORY	VENOM 250 S		X
3				
4				



Cód:10177121

Cód Original: 292400023-0001

No	MARCA	APLICACIONES	D	T
1	AKT	VOGE 300 RALLY		X
2	VICTORY	SWITCH 150		X
3				
4				



Cód:10177132

Cód Original: 659D04GOGORO3R

No	MARCA	APLICACIONES	D	T
1	GOGORO ELEC.	GOGORO 2 / GOGORO 2 ABS		X
2	GOGORO ELEC.	GOGORO S2 / CAFE RACER		X
3	GOGORO ELEC.	PLUS		X
4	YAMAHA	EC 05		X



Cód:10177136

Cód Original: 53013-1329-000001

No	MARCA	APLICACIONES	D	T
1	AKT	FLEX 125 CBS		X
2				
3				
4				

Cód:10177107

Cód Original: 45310-QSM-F01

No	MARCA	APLICACIONES	D	T
1	VICTORY	BLACK 171		X
2	FRATELLI	SFRX 125		X
3	SUPERSOCO	TS 1200		X
4	SUPERSOCO	TC MAX		X

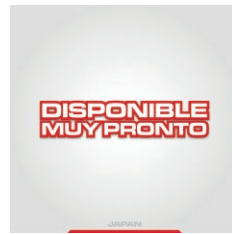

Cód:10177130

Cód Original: N/A

No	MARCA	APLICACIONES	D	T
1	AKT	CR 4 150 CBS		X
2				
3				
4				



Cód:10177134

Cód Original: N/A

No	MARCA	APLICACIONES	D	T
1	ITALIKA	ATV 190		X
2				
3				
4				

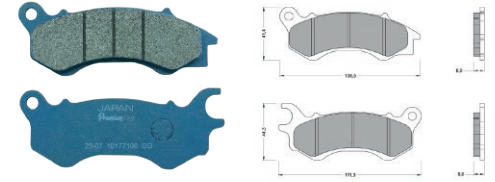

Cód:10177108

Cód Original: 11071105

No	MARCA	APLICACIONES	D	T
1	VICTORY	HUNTER 150		X
2	SWM	GRAND MILANO OUTLAW 125		X
3	SWM	RS 125 R		X
4				

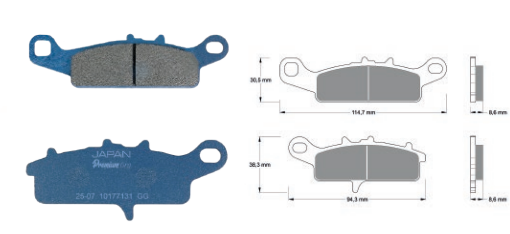

Cód:10177131

Cód Original: 659D04GOGORO23F

No	MARCA	APLICACIONES	D	T
1	GOGORO ELEC.	GOGORO 2		X
2	YAMAHA	RS ZERO 100		X
3				
4				



Cód:10177135

Cód Original: 06455AANE00S

No	MARCA	APLICACIONES	D	T
1	HERO	HUNK 125 R		X
2				
3				
4				



- Bandas de freno *Premium*
- Pastillas **JAPAN** *Premium Organics*
- Pastillas **JAPAN** *Premium Semimetallics*
- Pastillas **JAPAN** *Racing*
- Pastillas **JAPAN** *COMPETITION PRO*
- Pastillas **JAPAN** *Bike*
- Maniguetas
- Bases de Espejo
- Conjunto Base + Manigueta
- Discos de Freno
- Reposapiés
- Ejes de Rueda
- Ejes de Cambio
- Varillas de Freno
- Cuñas
- Pedales de Encendido
- Pedales de Cambio
- Pedales de Freno
- Tornillos
- Resortes de Banda
- Otros Productos
- Rines **Murelli**

Industrias Japan S.A



INDUSTRIAS JAPAN S.A.
Fabricantes de partes para motocicletas

Live safely





CATÁLOGO DE PRODUCTOS

2026



JAPAN
INDUSTRIAS
JAPAN S.A.

www.industriasjapan.com



INDUSTRIAS JAPAN S.A.

Fabricantes de partes para motocicletas

Live safely

NUESTRA HISTORIA

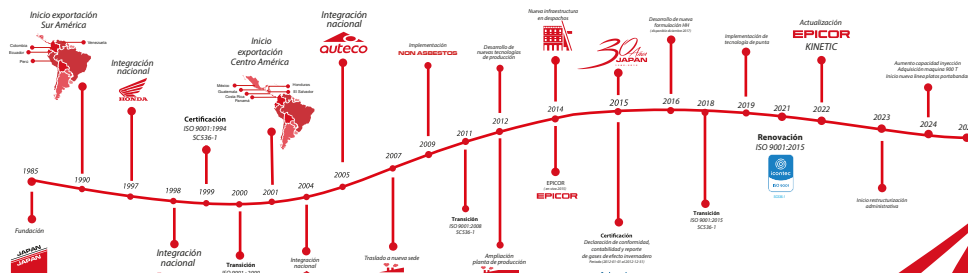

¿QUÉ ES EL COEFICIENTE DE FRICCIÓN?

Las características de fricción de las bandas y pastillas de freno, se miden por el comportamiento del coeficiente de fricción del material de desgaste en pruebas específicas de laboratorio. La norma americana SAE J866 ha clasificado los materiales en 7 niveles de acuerdo con rangos de fricción, los cuales se identifican con 2 letras, una representa el coeficiente de fricción normal o en frío y la segunda su comportamiento en caliente. En frenos, los niveles E y F corresponden a rangos de fricción corrientes y los niveles G y H, representan altos coeficientes de fricción.

Clasificación de niveles de fricción Según SAE J866 (CHASE)

COEFICIENTE DE FRICCIÓN	CÓDIGO DE FRICCIÓN		
	FRÍO	CALIENTE	
0.45 - 0.55 PREMIUM	G	G	
0.45 - 0.55 PREMIUM	G	G	
0.45 - 0.55 High Performance	HH/GG	HH/GG	
Mayor a 0.55 Alto Desempeño/ High Performance	H	H	



JAPAN Premium Organics

JAPAN Premium Pastillas

Coeficiente de fricción **GG**

Premium para motos de 80 cc. a 250 cc.



JAPAN Racing

Coeficiente de fricción **HH y GG**

Alto desempeño para motos de 300 cc. en adelante



Coeficiente de fricción **HH**

High Performance



*(HH y HH orientada solo para motos de carrera o ambientes de alta exigencia).

INDUSTRIAS JAPAN S.A fabrica los materiales de fricción de las bandas y pastillas con coeficientes **GG** para motocicletas del mercado tradicional y coeficiente **HH** para frenos en motocicletas de alto cilindraje.

CLASIFICACIÓN PASTILLAS JAPAN



Pastillas de freno **JAPAN**
Premium Organics



Calidad *Premium*

Motocicletas de trabajo con gran exigencia de frenado en movilidad de alto tráfico.

Tipo *Orgánico* a base de fibras minerales y orgánicas, elastómeros, partículas activadoras y reguladoras del coeficiente de fricción; y resinas aglomerantes.

Mayor coeficiente de fricción para una respuesta de frenado más rápida. Menor distancia de parada.



Coeficiente de fricción
 μ : 0.45 - 0.55



Pastillas de freno **JAPAN**
Premium Semimetallics



Calidad *Premium*

Motocicletas de calle y todoterreno con gran exigencia de frenado. Ideales en terrenos destapados y estilos de conducción más agresivos.

Tipo *Orgánico* a base de fibras minerales y fibras de acero.

Mayor coeficiente de fricción para una respuesta de frenado más rápida. Menor distancia de parada.



Coeficiente de fricción
 μ : 0.45 - 0.55



Pastillas de freno **JAPAN**
Racing



Freno
DELANTERO



Pastillas de freno **JAPAN**
Racing



Freno
TRASERO

Calidad High Performance

Motocicletas de alto cilindraje (> 250 cc), Con gran exigencia de frenado en diferentes estilos de conducción desde moderado hasta deportivo.

Compuesto: *Orgánico* a base de fibras minerales, polvos metálicos, elementos activadores y reguladores del coeficiente de fricción y resina aglomerante. Contiene partículas especiales y platina con recubrimiento en cobre para alta disipación de calor. Productos con alto coeficiente de fricción: Pastillas delanteras con nivel HH y traseras con nivel GG.



Coeficiente de fricción
Delanteras μ : ≥ 0.55
Traseras μ : 0.45 - 0.55



JAPAN
Bike



Pastillas de freno **JAPAN**

COMPETITION PRO



Pastillas de freno con un material de fricción de muy alto coeficiente (HH). La platina de respaldo incorpora un sistema de retención por grafilado que mejora la adherencia del compuesto.

Son productos totalmente libres de asbesto, compuestos por fibras minerales, fibras metálicas, partículas especiales para la alta disipación de calor, resina aglomerante, elementos activadores y reguladores del coeficiente de fricción. Por su naturaleza orgánica, son pastillas suaves que protegen los discos de freno contra el desgaste excesivo.

El nivel de fricción es HH, tanto en las pastillas delanteras como en las traseras, Clasificando estas pastillas como un producto High Performance.





PASTILLAS DE FRENO

Premium Semimetallics

1

INDUSTRIAS JAPAN S.A.
Fabrica 5 tipos de pastillas de freno:

JAPAN
COMPETITION PRO

JAPAN
Racing

JAPAN
Premium Organics

JAPAN
Premium Semimetallics

JAPAN
Bike

2

El material de fricción, totalmente LIBRE DE ASBESTO, ha sido desarrollado con el apoyo de centros de investigación y desarrollo en Estados Unidos y Alemania.

3

Cumplen con las dimensiones requeridas para garantizar su ensamble y funcionamiento en la motocicleta.

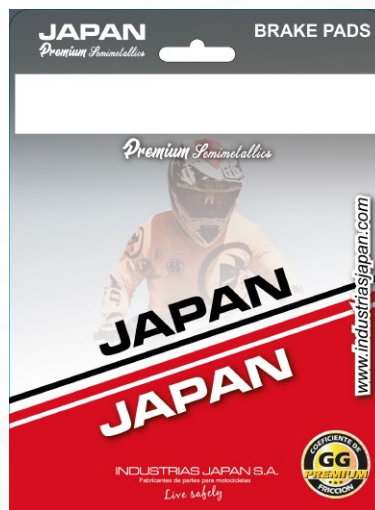

Las pastillas de freno de **INDUSTRIAS JAPAN S.A.** son el resultado de más de 40 años de trabajo y mejora continua.

Son fabricadas por proceso de moldeo positivo garantizando la homogeneidad del producto en cuanto a su densidad, dureza y desgaste, proporcionando un desempeño seguro y estable en diferentes condiciones climáticas.

El coeficiente de fricción y el desgaste son controlados continuamente con pruebas de laboratorio bajo norma JIS D4411 (Japan Industrial Standard) y SAE J661 (Automotive Engineering).



INDUSTRIAS JAPAN S.A.
Fabricantes de partes para motocicletas
Live safely





PASTILLAS DE FRENO

Premium Semimetálicas



JAPAN

Frenos de Alto Desempeño

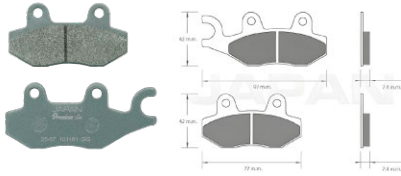

Cód:101161

Cód Original: 1S3-W0045-10

No	MARCA	APLICACIONES	D	T
1	KYMCO	AGILITY 125	X	
2	KAWASAKI	KLX 150		X
3	SUZUKI	EN 125 / GS 125	X	
4	YAMAHA	XTZ 125 / XTZ 250	X	

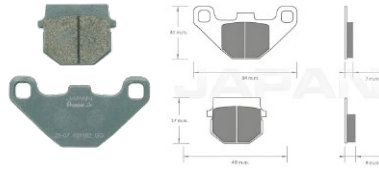

Cód:101162

Cód Original: 453036

No	MARCA	APLICACIONES	D	T
1	KAWASAKI	KMX 125 PRIMER MODELO	X	
2	SUZUKI	AN 100 SPACE		X
4				

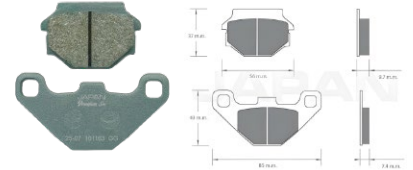

Cód:101163

Cód Original: 42385-94Y

No	MARCA	APLICACIONES	D	T
1	HAJUE	VS 125	X	
2	KAWASAKI	KMX 125 PRIMER MODELO		X
3	KYMCO	UNI-K 110	X	
4	SUZUKI	TR 125	X	

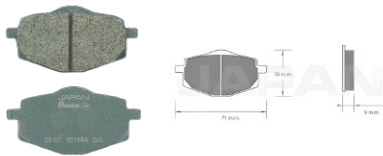

Cód:101164

Cód Original: 1UY-W0045-00

No	MARCA	APLICACIONES	D	T
1	YAMAHA	XT 350 / XT 500	X	
2	YAMAHA	DT 200		X
3	YAMAHA	SEROW 225	X	
4	YAMAHA	XT 600 E	X	

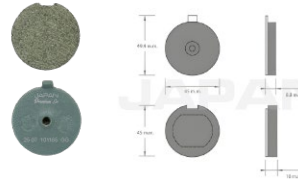

Cód:101165

Cód Original: 59300-39820

No	MARCA	APLICACIONES	D	T
1	AUTECO	FURAX 150	X	
2	VENTO	CROSSMAX 200	X	
3	SUZUKI	GP 125	X	
4	UM	DUAL SPORTS 125	X	
5				
6				



Cód:101166

Cód Original: 2NA-W0045-00

No	MARCA	APLICACIONES	D	T
1	YAMAHA	YW 100 BW'S 100	X	
2	YAMAHA	JOG 50	X	
3	YAMAHA	AXIS 90	X	
4				

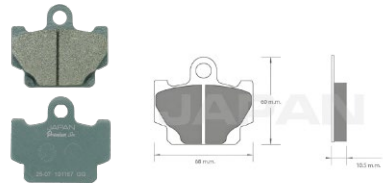

Cód:101167

Cód Original: 11H-W0045-00

No	MARCA	APLICACIONES	D	T
1	YAMAHA	RX 115 S	X	
2	YAMAHA	RX 125	X	
3	YAMAHA	RX 135	X	
4				

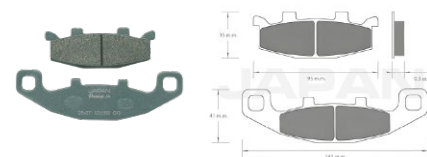

Cód:101168

Cód Original: 43082-1068

No	MARCA	APLICACIONES	D	T
1	KAWASAKI	GPZ 400	X	
2	KAWASAKI	EX 500	X	
3	KAWASAKI	ZEPHYR 550	X	
4	SUZUKI	GS 500 (ANTES DEL '95)	X	



Cód:101169

Cód Original: 59100-16810

No	MARCA	APLICACIONES	D	T
1	SUZUKI	GS 500	X	
2	SUZUKI	KATANA 750	X	
3	SUZUKI	KATANA 600	X	
4	SUZUKI	GSXR 600 (97-03)	X	



Cód:1011610

Cód Original: 06455-GBZ-006

No	MARCA	APLICACIONES	D	T
1	KAWASAKI	KLX 150	X	
2	SUZUKI	DR 200	X	
3	POLARIS	OUTLAW 70 EH	X	
4	AKT	XM 180 / 200 / SM 200	X	

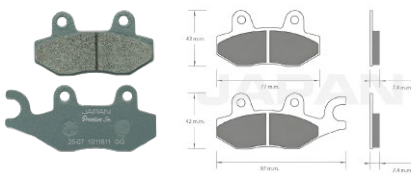

Cód:1011611

Cód Original: 06455-KR3-415

No	MARCA	APLICACIONES	D	T
1	KAWASAKI	MAGIC / CHEER / KAZE / VICTOR	X	
2	SUZUKI	VIVA 115 F.D.	X	
3	HONDA	CBX250 TWISTER (2002-2009)	X	



Cód:1011612

Cód Original: 21050-BN1-00000

No	MARCA	APLICACIONES	D	T
1	PIAGGIO	TYPHOON 50	X	
2	YAMAHA	YG 50 Z	X	
3				
4				



PASTILLAS DE FRENO

Premium Semimetálicas



JAPAN

Frenos de Alto Desempeño

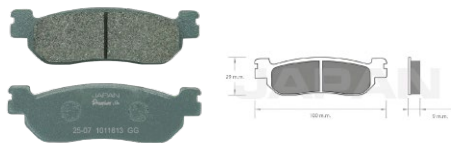

Cód:1011613

Cód Original: 10C-25806-00

No	MARCA	APLICACIONES	D	T
1	YAMAHA	DT 125 D	X	
2	YAMAHA	DT 175 DS	X	
3	YAMAHA	CRYPTON 110 ED	X	
4	YAMAHA	YBR 125 BRASIL	X	

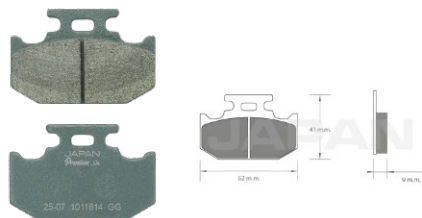

Cód:1011614

Cód Original: 3C5-25806-00

No	MARCA	APLICACIONES	D	T
1	YAMAHA	CBR 250 R (11-17)	X	
2	SUZUKI	INAZUMA 250	X	
3	YAMAHA	V STROM 250	X	
4	YAMAHA	CB 500 X / NC 750	X	

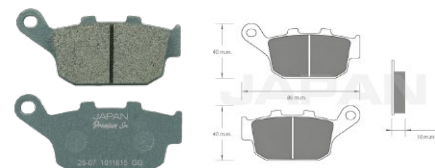

Cód:1011615

Cód Original: 06435-K64-N01

No	MARCA	APLICACIONES	D	T
1	HONDA	CBR 250 R (11-17)	X	
2	SUZUKI	INAZUMA 250	X	
3	SUZUKI	V STROM 250	X	
4	HONDA	CB 500 X / NC 750	X	

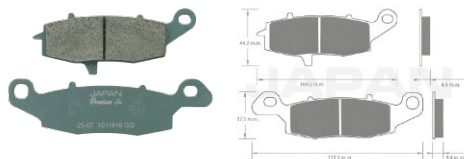

Cód:1011616

Cód Original: 43082-0010

No	MARCA	APLICACIONES	D	T
1	KAWASAKI	ER 6N	X	
2	SUZUKI	GLADIUS 650 / GSF BANDIT 650	X	
3	SUZUKI	SFV 650 GLADIUS / GSR 750	X	
4	SUZUKI	V STROM 650 CLASSIC / 1000	X	

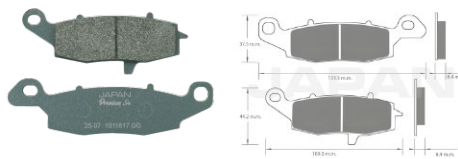

Cód:1011617

Cód Original: 43080-1187

No	MARCA	APLICACIONES	D	T
1	KAWASAKI	ER 6N	X	
2	SUZUKI	GLADIUS 650 / GSF BANDIT 650	X	
3	SUZUKI	SFV 650 GLADIUS / GSR 750	X	
4	SUZUKI	V STROM 650 CLASSIC / 1000	X	
5				
6				

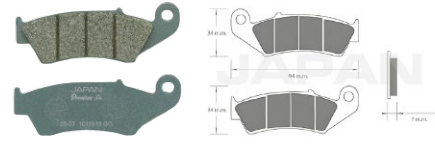

Cód:1011619

Cód Original: 06455-GZ8-405

No	MARCA	APLICACIONES	D	T
1	HONDA	XR 125 L / XR 150 L	X	
2	HONDA	XR 190 L / XR 190 CT	X	
3	HONDA	TORNADO 250	X	
4	HONDA	XL 200 / XL 250	X	

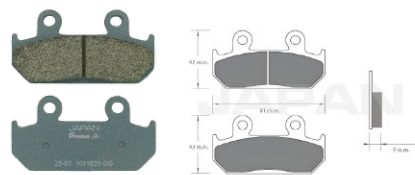

Cód:1011620

Cód Original: 45105-KT7-751

No	MARCA	APLICACIONES	D	T
1	HONDA	CB 450	X	
2	HONDA	CBR 600 MOD. ANTIGUO	X	
3				
4				

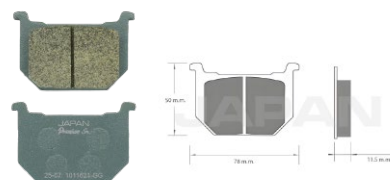

Cód:1011621

Cód Original: 59130-45230

No	MARCA	APLICACIONES	D	T
1	SUZUKI	GN 250 J	X	
2	SUZUKI	GS 250 (91-94)	X	
3				
4				

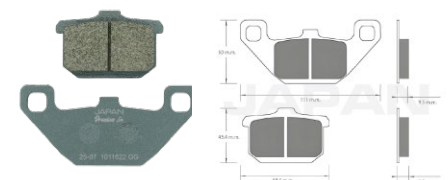

Cód:1011622

Cód Original: 43082-1029

No	MARCA	APLICACIONES	D	T
1	KAWASAKI	VN 400	X	
2	KAWASAKI	VN 800	X	
3	KAWASAKI	VN 1500	X	
4				

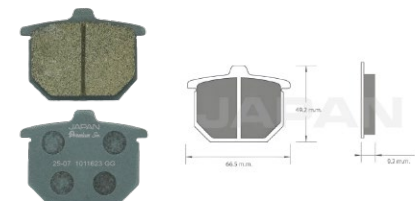

Cód:1011623

Cód Original: 45105-410-004

No	MARCA	APLICACIONES	D	T
1	HONDA	CB 750 F	X	
2	HONDA	CBX 100	X	
3	HONDA	CB 250 N	X	
4	HONDA	GL 400 / CX 500	X	

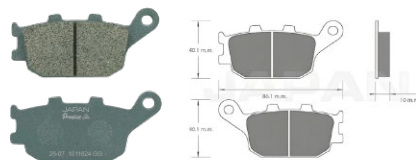

Cód:1011624

Cód Original: 06435-MEE-006

No	MARCA	APLICACIONES	D	T
1	HONDA	CBF 500 / CBF 600	X	
2	HONDA	CBR 600 F2	X	
3	HONDA	V STROM 800	X	

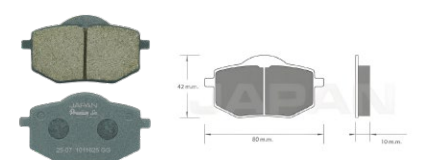

Cód:1011625

Cód Original: 2GV-W0045-00

No	MARCA	APLICACIONES	D	T
1	YAMAHA	XV 535 VIRAGO	X	
2				
3				
4				



PASTILLAS DE FRENO

Premium Semimetálicas



JAPAN

Frenos de Alto Desempeño

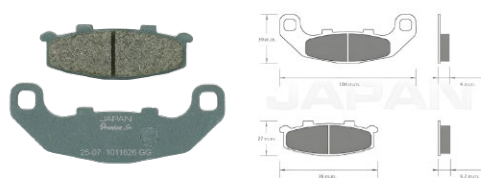

Cód:1011626

Cód Original: 43082-1075

No	MARCA	APLICACIONES	D	T
1	KAWASAKI	ZEPHYR 550	X	X
2	KAWASAKI	GPZ 400	X	
3	KAWASAKI	EX 250 F	X	X
4				

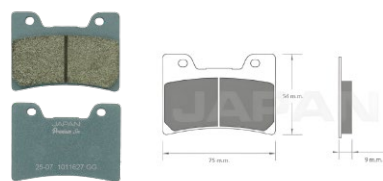

Cód:1011627

Cód Original: 3GM-W0045-00

No	MARCA	APLICACIONES	D	T
1	YAMAHA	FZR 600	X	X
2	YAMAHA	V MAX 1200	X	
3	YAMAHA	RD 250	X	X
4	YAMAHA	FZR 1000	X	X

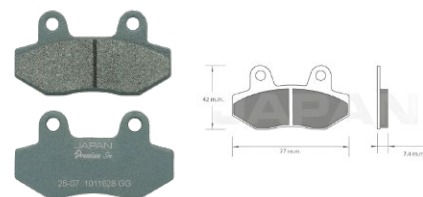

Cód:1011628

Cód Original: 06435-K64-N01

No	MARCA	APLICACIONES	D	T
1	AKT	NKD / NKDR 125 / AK 110 S	X	X
2	BERA M.	BR 150 LEÓN / BR 200	X	X
3	FRATELLI	FTR 125 / SFR 125 / SFS 125	X	X
4	VICTORY	LIFE / NEW LIFE / VENOM 14	X	X

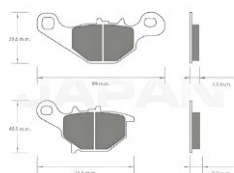

Cód:1011629

Cód Original: 43082-S001

No	MARCA	APLICACIONES	D	T
1	SUZUKI	ADDRESS 110	X	X
2	SUZUKI	ADDRESS 125 F.L.	X	
3	SUZUKI	ADDRESS NM 113 / NZ 113	X	X
4	KAWASAKI	KMX 125 ÚLTIMO MODELO	X	X

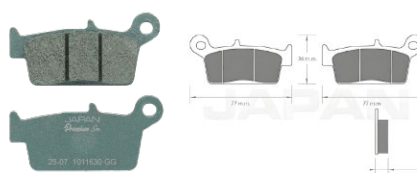

Cód:1011630

Cód Original: 06435-KCZ-000

No	MARCA	APLICACIONES	D	T
1	HONDA	XRE 300 PRIMER MODELO	X	X
2	HONDA	XR 250 R	X	X
3	HONDA	XR 600 / XR 650 L	X	X
4	KAWASAKI	KLX 250 / KLX 300	X	X
5	SUZUKI	DR Z 400	X	X
6				

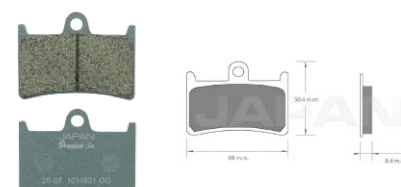

Cód:1011631

Cód Original: 1D7-W0045-00

No	MARCA	APLICACIONES	D	T
1	YAMAHA	YZF 600	X	X
2	YAMAHA	MT 07	X	X
3	YAMAHA	TRACER 900	X	X
4	YAMAHA	YZF R1 / YZF R6	X	X

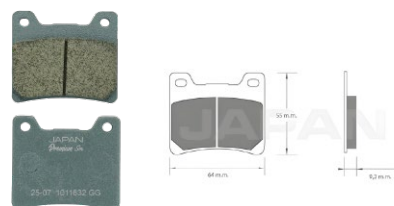

Cód:1011632

Cód Original: 1FK-W0045-00

No	MARCA	APLICACIONES	D	T
1	YAMAHA	FZ 600	X	X
2	YAMAHA	VIRAGO 750 / VIRAGO 1100	X	X
3	YAMAHA	V STAR 1100 / V MAX 1200	X	X
4				

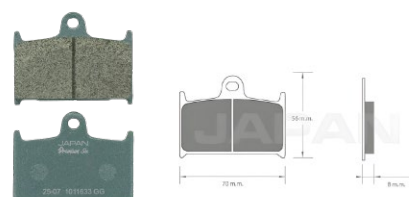

Cód:1011633

Cód Original: 2020073-T0301

No	MARCA	APLICACIONES	D	T
1	TRIUMPH	TIGER EXPLORER	X	X
2	TRIUMPH	THUNDERBIRD COMANDER	X	X
3				
4				

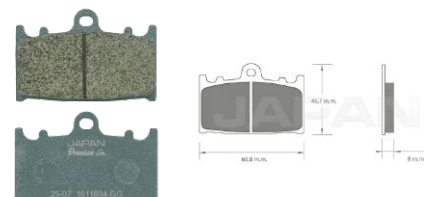

Cód:1011634

Cód Original: N/A

No	MARCA	APLICACIONES	D	T
1	SUZUKI	SV 650 ABS	X	X
2	KAWASAKI	VERSYS 1000	X	X
3	SUZUKI	GSF BANDIT 650 SA/1250 F ABS	X	X
4	KAWASAKI	VULCAN VAQUERO/VOYAGER 1700	X	X

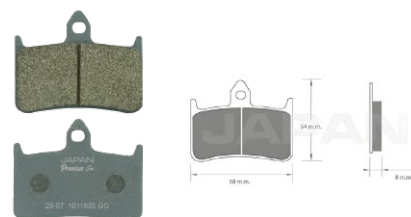

Cód:1011635

Cód Original: 06455-KEA-006

No	MARCA	APLICACIONES	D	T
1	HONDA	CBR 600 / CBR 900 RR	X	X
2	HONDA	CBR 1000	X	X
3	HONDA	CB 900 HORNET	X	X
4	HONDA	VTR 1000 F	X	X

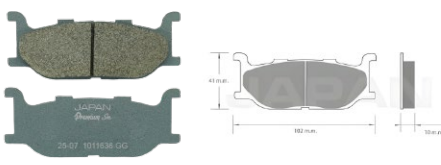

Cód:1011636

Cód Original: 3LP-25805-00

No	MARCA	APLICACIONES	D	T
1	YAMAHA	XV 535	X	X
2	YAMAHA	V STAR 650	X	X
3	YAMAHA	ROYAL STAR 1300	X	X

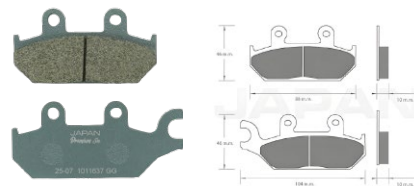

Cód:1011637

Cód Original: 1XD-25805-10

No	MARCA	APLICACIONES	D	T
1	YAMAHA	XT 600	X	X
2	YAMAHA	TENERE 750	X	X
3				
4				



PASTILLAS DE FRENO

Premium Semimetálicas



JAPAN

Frenos de Alto Desempeño



Cód:1011638

Cód Original: 252-0002A

No	MARCA	APLICACIONES	D	T
1	HUSQVARNA	HUSKY 50	X	
2	SUZUKI	DR 50	X	
3	KTM	SX 60	X	
4				

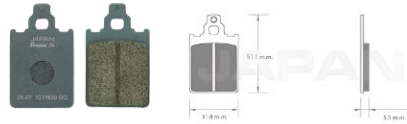

Cód:1011639

Cód Original: 494762

No	MARCA	APLICACIONES	D	T
1	PIAGGIO	PX 150 VESPA	X	
2				
3				
4				

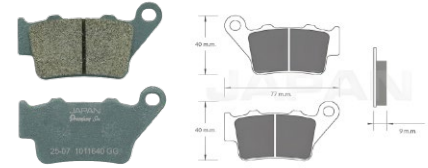

Cód:1011640

Cód Original: 06435-MAK-003

No	MARCA	APLICACIONES	D	T
1	SUZUKI	GIXXER 250/ 150 F.I./ 150 F.I. SF	X	X
2	BAJAJ	PULSAR NS 200 / RS 200	X	X
3	KTM	DUKE 250 / 390	X	X
4	CF MOTO	250 NK	X	X

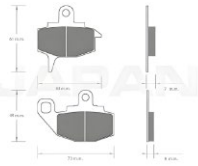

Cód:1011641

Cód Original: 43082-1072

No	MARCA	APLICACIONES	D	T
1	KAWASAKI	KLR 650 (1988-1995)	X	
2	KAWASAKI	KX 500	X	
3				
4				

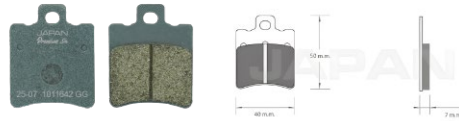

Cód:1011642

Cód Original: 06455-GBY-910

No	MARCA	APLICACIONES	D	T
1	APRILIA	MOJITO 125	X	
2	PIAGGIO VESPA	ZIP 50 SP	X	
3				
4				
5				
6				

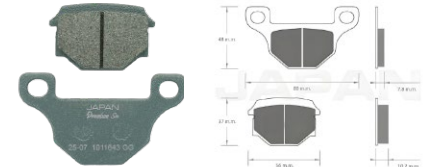

Cód:1011643

Cód Original: 59300-29820

No	MARCA	APLICACIONES	D	T
1	SUZUKI	FZ GN 125 H / F	X	
2	FRATELLI	FT 125	X	
3	VENTO	THRILLER 210	X	
4	UM	MAGNETIC 125	X	

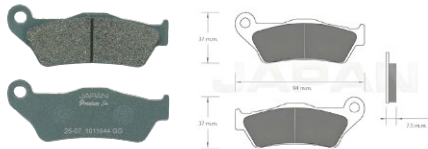

Cód:1011644

Cód Original: 000-306-546-250

No	MARCA	APLICACIONES	D	T
1	BAJAJ	PULSAR 180 / 135 LS	X	
2	BAJAJ	NS 125 / DISCOVER 125 ST	X	
3	YAMAHA	R 15 (22-24)	X	
4	YAMAHA	FZ 16 / FZ-S / FZ 25 / FZ 3.0	X	

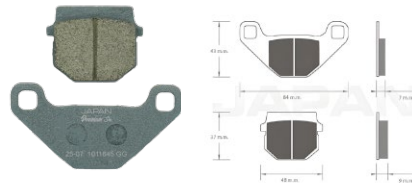

Cód:1011645

Cód Original: N/A

No	MARCA	APLICACIONES	D	T
1	VENTO	ZIP 50 (02-04)	X	
2				
3				
4				

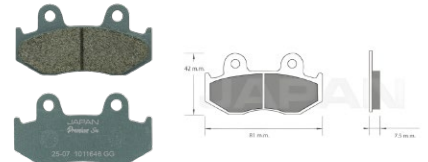

Cód:1011646

Cód Original: 06455-GCC-930

No	MARCA	APLICACIONES	D	T
1	HONDA	XLR 250	X	
2				
3				
4				

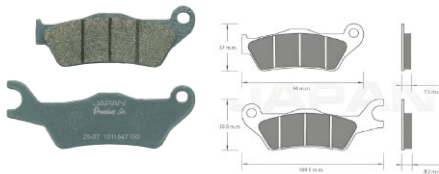

Cód:1011647

Cód Original: 06455-KCC-841

No	MARCA	APLICACIONES	D	T
1	HONDA	CBF 125 STUNNER	X	
2	HONDA	CBF 150 UNICORN	X	
3	HONDA	CB 110 DLX	X	
4				

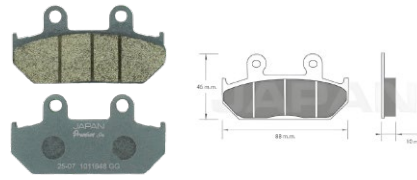

Cód:1011648

Cód Original: 06445-MS8-405

No	MARCA	APLICACIONES	D	T
1	HONDA	NV 400 STEED	X	
2	HONDA	CBR 600 F2 / CBR 1000	X	
3	HONDA	VRF 750	X	

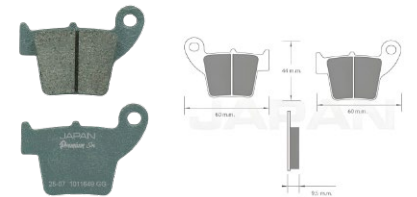

Cód:1011649

Cód Original: 06435-KRN-711

No	MARCA	APLICACIONES	D	T
1	HONDA	CRF 150 RB	X	
2	HONDA	CR 250	X	
3	HONDA	CRF 250 RC	X	
4	HONDA	CRE 450 F	X	



PASTILLAS DE FRENO

Premium Semimetálicas



JAPAN

Frenos de Alto Desempeño

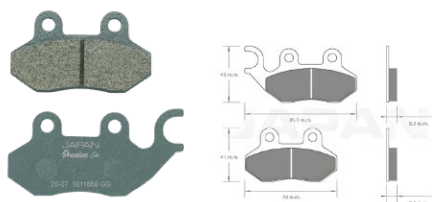

Cód:1011650

Cód Original: 45105-G02-000

No	MARCA	APLICACIONES	D	T
1	AKT	DYNAMIC K 125	X	
2	AKT	DYNAMIC KLASSIC 125	X	
3	AKT	JET 14 EVO F.I.	X	
4	SYM	CROX 125 / 150 / 180 F.I.	X	

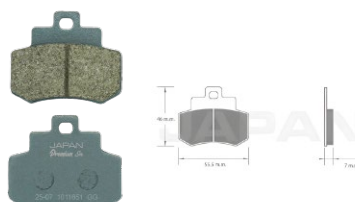

Cód:1011651

Cód Original: 43105-KKC4-306

No	MARCA	APLICACIONES	D	T
1	KYMCO	GRAND DINK 250		X
2				
3				
4				

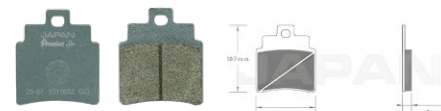

Cód:1011652

Cód Original: 156924

No	MARCA	APLICACIONES	D	T
1	KYMCO	GRAND DINK 250		X
2	SYM	JOYMAX 125		X
3	SYM	JOYMAX 250 i		X
4	SYM	JOYMAX 300 i		X



Cód:1011653

Cód Original: 06435-HA5-405

No	MARCA	APLICACIONES	D	T
1	HONDA	TRX 250	X	
2	SUZUKI	DR 200 - X	X	
3	HONDA	FOURTRAX	X	
4	YAMAHA	ATV YFS 200	X	

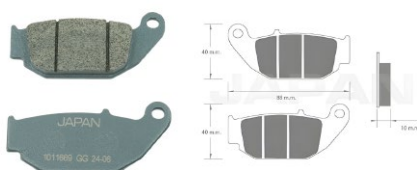

Cód:1011669

Cód Original: 06455-2G2-A20

No	MARCA	APLICACIONES	D	T
1	HONDA	CB INVICTA / CB 190 R	X	
2	HERO	HUNK 190R / X-PULSE 200	X	
3	SUZUKI	GIXXER SF/GSXR 150/GSXS 150	X	
4	HONDA	XRE 300 / XR 300 L	X	
5				
6				

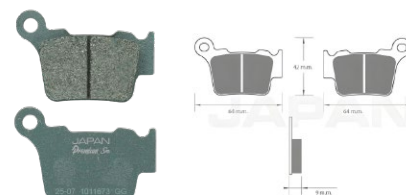

Cód:1011673

Cód Original: 06455-K8W-880

No	MARCA	APLICACIONES	D	T
1	HUSQVARNA	TC 125		X
2	HUSQVARNA	TE 150 i		X
3	KTM	SX 125		X
4	KTM	EXC 150 TPI		X

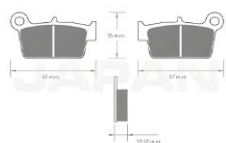

Cód:1011672

Cód Original: 52S-F5811-00

No	MARCA	APLICACIONES	D	T
1	YAMAHA	WR 250 F - N		X
2	YAMAHA	YZ 250 FX		X
3	SUZUKI	RMZ 250/450		X
4	YAMAHA	YZ 125		X

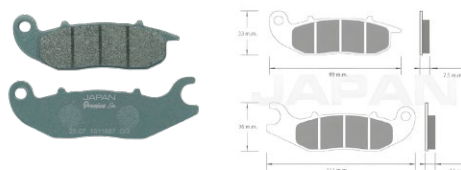

Cód:1011687

Cód Original: 2DP-F582W-00

No	MARCA	APLICACIONES	D	T
1	APRILIA	SR GT 200N		X
2	HONDA	CRF 250 RALLY		X
3	VENTO	SCREAMER 250		X
4	YAMAHA	XTZ 150 CROSSER / XTZ 250		X



- Bandas de freno *Premium*
- Pastillas **JAPAN** *Premium Organics*
- Pastillas **JAPAN** *Premium Semimetallics*
- Pastillas **JAPAN** *Racing*
- Pastillas **JAPAN** *COMPETITION PRO*
- Pastillas **JAPAN** *Bike*
- Maniguetas
- Bases de Espejo
- Conjunto Base + Manigueta
- Discos de Freno
- Reposapiés
- Ejes de Rueda
- Ejes de Cambio
- Varillas de Freno
- Cuñas
- Pedales de Encendido
- Pedales de Cambio
- Pedales de Freno
- Tornillos
- Resortes de Banda
- Otros Productos
- Rines **Murelli**

Industrias Japan S.A



INDUSTRIAS JAPAN S.A.
Fabricantes de partes para motocicletas

Live safely





CATÁLOGO DE PRODUCTOS

2026



JAPAN
INDUSTRIAS
JAPAN S.A.

www.industriasjapan.com



INDUSTRIAS JAPAN S.A.

Fabricantes de partes para motocicletas

Live safely

NUESTRA HISTORIA

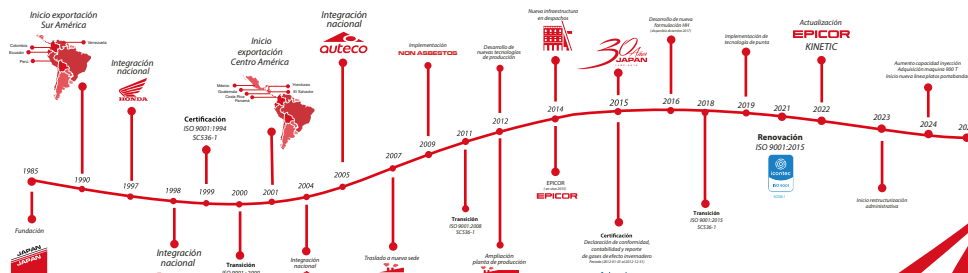

¿QUÉ ES EL COEFICIENTE DE FRICCIÓN?

Las características de fricción de las bandas y pastillas de freno, se miden por el comportamiento del coeficiente de fricción del material de desgaste en pruebas específicas de laboratorio. La norma americana SAE J866 ha clasificado los materiales en 7 niveles de acuerdo con rangos de fricción, los cuales se identifican con 2 letras, una representa el coeficiente de fricción normal o en frío y la segunda su comportamiento en caliente. En frenos, los niveles E y F corresponden a rangos de fricción corrientes y los niveles G y H, representan altos coeficientes de fricción.

Clasificación de niveles de fricción Según SAE J866 (CHASE)

COEFICIENTE DE FRICCIÓN	CÓDIGO DE FRICCIÓN		
	FRÍO	CALIENTE	
0.45 - 0.55 PREMIUM	G	G	
0.45 - 0.55 PREMIUM	G	G	
0.45 - 0.55 High Performance	HH/GG	HH/GG	
Mayor a 0.55 Alto Desempeño/ High Performance	H	H	



JAPAN Premium Organics

JAPAN Premium Amovibles

Coeficiente de fricción **GG**

Premium para motos de 80 cc. a 250 cc.



JAPAN Racing

Coeficiente de fricción **HH y GG**

Alto desempeño para motos de 300 cc. en adelante



Coeficiente de fricción **HH**

High Performance



*(HH y HH orientada solo para motos de carrera o ambientes de alta exigencia).

INDUSTRIAS JAPAN S.A fabrica los materiales de fricción de las bandas y pastillas con coeficientes **GG** para motocicletas del mercado tradicional y coeficiente **HH** para frenos en motocicletas de alto cilindraje.

CLASIFICACIÓN PASTILLAS JAPAN



Pastillas de freno **JAPAN**
Premium Organics



Calidad *Premium*

Motocicletas de trabajo con gran exigencia de frenado en movilidad de alto tráfico.

Tipo *Orgánico* a base de fibras minerales y orgánicas, elastómeros, partículas activadoras y reguladoras del coeficiente de fricción; y resinas aglomerantes.

Mayor coeficiente de fricción para una respuesta de frenado más rápida. Menor distancia de parada.



Coeficiente de fricción
 μ : 0.45 - 0.55



Pastillas de freno **JAPAN**
Premium Semimetálicas



Calidad *Premium*

Motocicletas de calle y todoterreno con gran exigencia de frenado. Ideales en terrenos destapados y estilos de conducción más agresivos.

Tipo *Orgánico* a base de fibras minerales y fibras de acero.

Mayor coeficiente de fricción para una respuesta de frenado más rápida. Menor distancia de parada.



Coeficiente de fricción
 μ : 0.45 - 0.55



Pastillas de freno **JAPAN**
Racing



Freno
DELANTERO



Pastillas de freno **JAPAN**
Racing



Freno
TRASERO

Calidad High Performance

Motocicletas de alto cilindraje (> 250 cc), Con gran exigencia de frenado en diferentes estilos de conducción desde moderado hasta deportivo.

Compuesto: *Orgánico* a base de fibras minerales, polvos metálicos, elementos activadores y reguladores del coeficiente de fricción y resina aglomerante. Contiene partículas especiales y platina con recubrimiento en cobre para alta disipación de calor. Productos con alto coeficiente de fricción: Pastillas delanteras con nivel HH y traseras con nivel GG.



Coeficiente de fricción
Delanteras μ : ≥ 0.55
Traseras μ : 0.45 - 0.55



JAPAN
Bike



Pastillas de freno **JAPAN**

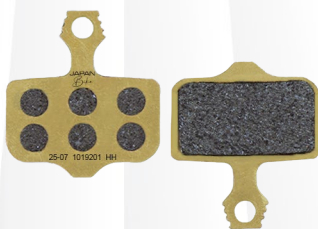

Pastillas de freno con un material de fricción de muy alto coeficiente (HH). La platina de respaldo incorpora un sistema de retención por grafilado que mejora la adherencia del compuesto.

Son productos totalmente libres de asbesto, compuestos por fibras minerales, fibras metálicas, partículas especiales para la alta disipación de calor, resina aglomerante, elementos activadores y reguladores del coeficiente de fricción. Por su naturaleza orgánica, son pastillas suaves que protegen los discos de freno contra el desgaste excesivo.

El nivel de fricción es HH, tanto en las pastillas delanteras como en las traseras, Clasificando estas pastillas como un producto High Performance.





PASTILLAS

JAPAN *Racing*

**EXCLUSIVO
PARA ALTO
CILINDRAJE**

1

INDUSTRIAS JAPAN S.A.

Fabrica 5 tipos de pastillas de freno:

JAPAN
COMPETITION PRO

JAPAN
Racing

JAPAN
Premium Organics

JAPAN
Premium Semimetallics

JAPAN
Bike

2

El material de fricción, totalmente LIBRE DE ASBESTO, ha sido desarrollado con el apoyo de centros de investigación y desarrollo en Estados Unidos y Alemania.

3

Cumplen con las dimensiones requeridas para garantizar su ensamble y funcionamiento en la motocicleta.

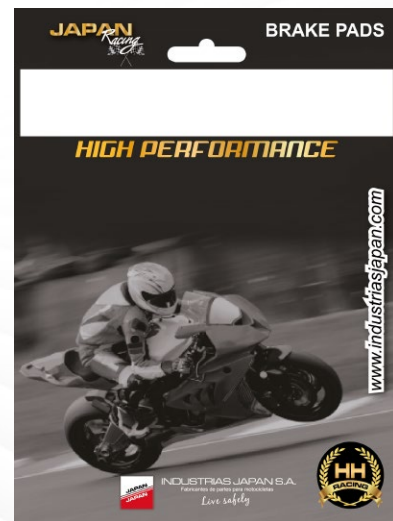

Las pastillas de freno de **INDUSTRIAS JAPAN S.A.** son el resultado de más de 40 años de trabajo y mejora continua.

Son fabricadas por proceso de moldeo positivo garantizando la homogeneidad del producto en cuanto a su densidad, dureza y desgaste, proporcionando un desempeño seguro y estable en diferentes condiciones climáticas.

El coeficiente de fricción y el desgaste son controlados continuamente con pruebas de laboratorio bajo norma JIS D4411 (Japan Industrial Standard) y SAE J661 (Automotive Engineering).



INDUSTRIAS JAPAN S.A.
Fabricantes de partes para motocicletas
Live safely





PASTILLAS DE FRENO

JAPAN Racing



JAPAN

Frenos de Alto Desempeño

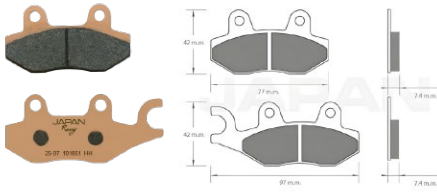

Cód:101851

HIGH PERFORMANCE HH

Cód. original: 43082-0060

No	MARCA	APLICACIONES	D	T
1	KAWASAKI	KLX 250 S / KX 250 / KLX 400 / KLR 650	X	X
2	KAWASAKI	BRUTE FORCE 650	X	X
3	KAWASAKI	ZX 1002 NINJA H2 SX	X	X
4	SUZUKI	BURGMAN 400 ABS	X	X
5	YAMAHA	WR 200	X	X
6	YAMAHA	YZF 450 / RAPTOR 700	X	X

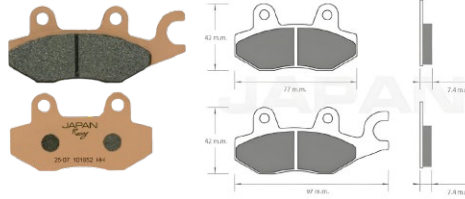

Cód:101852

HIGH PERFORMANCE HH

Cód. original: 43082-1128

No	MARCA	APLICACIONES	D	T
1	CAN - AM	COMMANDER 1000 / MAVERICK 1000 X	X	X
2	KAWASAKI	Z 250 / NINJA 300	X	X
3	KAWASAKI	BRUTE FORCE 650	X	X
4	KAWASAKI	KLR 650	X	X
5	SUZUKI	BURGMAN 400 ABS	X	X
6	YAMAHA	YZF 450 / RAPTOR 700	X	X

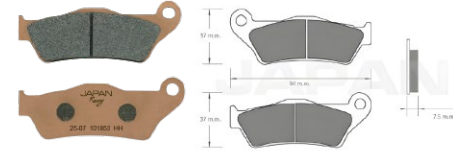

Cód:101853

HIGH PERFORMANCE HH

Cód. original: 50313030000

No	MARCA	APLICACIONES	D	T
1	APRILIA	SRV 850	X	X
2	HUSABERG	FE 450	X	X
3	HUSAVARNA	FC 250	X	X
4	KTM	EXC 250 SIX DAYS / EXC 300 SIX DAYS	X	X
5	KTM	ADVENTURE 990 / SUPER ADVENTURE R 1290	X	X
6	YAMAHA	XTZ TENERE 660 ABS / XTZ 700 TENERE	X	X

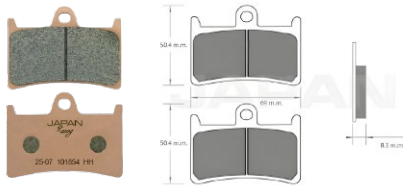

Cód:101854

HIGH PERFORMANCE HH

Cód. original: 3MA-W0045-00

No	MARCA	APLICACIONES	D	T
1	YAMAHA	FZ 6 S2 600 / FZR 600 / R6 R 600 / MT 07 A	X	X
2	YAMAHA	THUNDERCAT 600 / YZF 600 R6 / FZ 8	X	X
3	YAMAHA	FZ 8 N / MT 09 900 / MT 09 TRACER	X	X
4	YAMAHA	TDM 900 / FZ 1 / FZ S1 1000 / YZF R1	X	X
5	YAMAHA	YZF R1 M / S / SUPER TENERE 1200	X	X

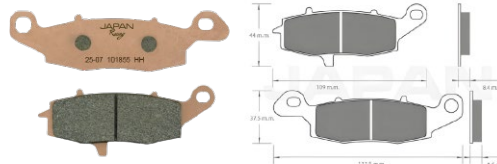

Cód:101855

HIGH PERFORMANCE HH

Cód. original: 59102-33870

No	MARCA	APLICACIONES	D	T
1	KAWASAKI	ER 6N / VERSYS 650	X	X
2	SUZUKI	FREEWIND XF 650	X	X
3	SUZUKI	GLADIUS 650	X	X
4	SUZUKI	GSF BANDIT 650/650A ABS /650S ABS/SA	X	X
5	SUZUKI	SPV 650 GLADIUS / GSR 750	X	X
6	SUZUKI	V STROM 650 CLASSIC / V STROM 1000 X	X	X

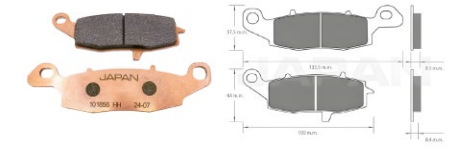

Cód:101856

HIGH PERFORMANCE HH

Cód. original: 59302-33850

No	MARCA	APLICACIONES	D	T
1	KAWASAKI	ER 6N / VERSYS 650	X	X
2	SUZUKI	GLADIUS 650 / GSF BANDIT 650	X	X
3	SUZUKI	GSF BANDIT 650/650A ABS /650S ABS/SA	X	X
4	SUZUKI	SPV 650 GLADIUS / V STROM 1000	X	X
5	SUZUKI	V STROM 650 CLASSIC / GSR 750	X	X

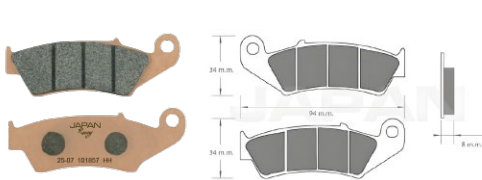

Cód:101857

HIGH PERFORMANCE HH

Cód. original: 59300-13830

No	MARCA	APLICACIONES	D	T
1	HONDA	CRF 230 F / CRF 250 RC / XR 600	X	X
2	HONDA	XRE 300 / CRF 450 R / XR 650	X	X
3	KAWASAKI	KX 450 F	X	X
4	SUZUKI	DRZ 400 / DR 650	X	X
5	YAMAHA	WR 450 F	X	X

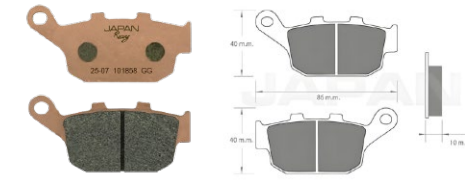

Cód:101858

HIGH PERFORMANCE GG

Cód. original: 06435-MGS-D32

No	MARCA	APLICACIONES	D	T
1	HONDA	CBR 250 R ABS / CB 500 F / CB 500 X	X	X
2	HONDA	CBR 500 R / CB 650 R / NC 750	X	X
3	HONDA	X ADV 750	X	X
4	TRIUMPH	TIGER 800 XC / TRIUMPH 800 XCX	X	X
5	YAMAHA	XJ 6 N	X	X

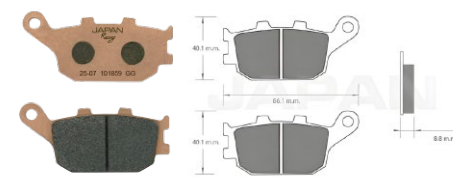

Cód:101859

HIGH PERFORMANCE GG

Cód. original: 69100-06830

No	MARCA	APLICACIONES	D	T
1	HONDA	CRF 1100 L	X	X
2	KAWASAKI	VERSYS 1000	X	X
3	SUZUKI	SPV 650 GLADIUS	X	X
4	SUZUKI	V STROM 650 CLASSIC / GSR 750	X	X
5	SUZUKI	GSF BANDIT 650/650A ABS /650S ABS/SA	X	X
6	YAMAHA	R6 R 600 / FZ 8 / MT 09 TRACER	X	X
7	YAMAHA	FZ 1 / YZF R1	X	X

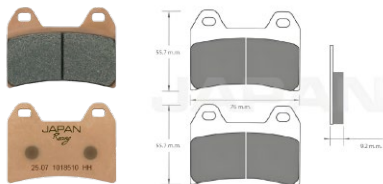

Cód:1018510

HIGH PERFORMANCE HH

Cód. original: 58713030000

No	MARCA	APLICACIONES	D	T
1	APRILIA	DORSODURO FACTORY 1200	X	X
2	BENELLI	LEONCINO 500	X	X
3	BMW	F 800 GT / R 1200	X	X
4	DUCATI	MULTISTRADA 1200	X	X
5	KTM	DUKE 690 ABS / DUKE 790	X	X
6	KTM	ADVENTURE 1190	X	X

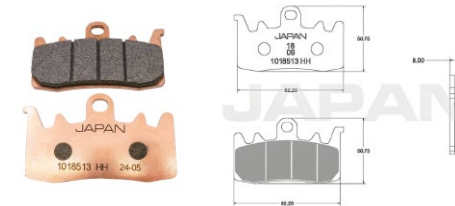

Cód:1018513

HIGH PERFORMANCE HH

Cód. original: 07BB38LA

No	MARCA	APLICACIONES	D	T
1	APRILIA	RS 660 / RSV 1000 TUGNO R ABS	X	X
2	APRILIA	RSV 1100 TUGNO V4 RR	X	X
3	APRILIA	CAPONORD 1200	X	X
4	BMW	F 800 R / F 900 R / F 900 XR / F 1000 R	X	X
5	KAWASAKI	Z H2	X	X

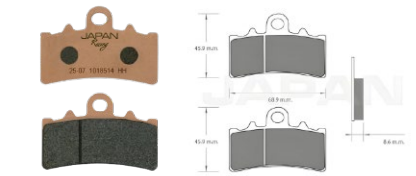

Cód:1018514

HIGH PERFORMANCE HH

Cód. original: 90113030000

No	MARCA	APLICACIONES	D	T
1	BMW	G 310 GS / G 310 R	X	X
2	KTM	DUKE 250 / RC 250 / DUKE 390	X	X
3	KTM	RC 390	X	X
4	TVS	APACHE 310	X	X
5				



PASTILLAS DE FRENO

JAPAN Racing



JAPAN

Frenos de Alto Desempeño

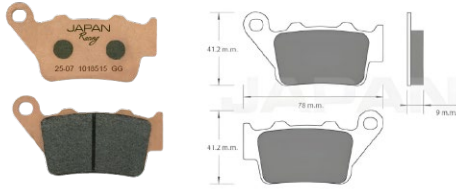

Cód:1018515

HIGH PERFORMANCE GG

Cód. original: 61340761A

No	MARCA	APLICACIONES	D	T
1	BMW	G 310 GS / F 800 R / S 1000 RR	X	X
2	KTM	DUKE 390 / DUKE 690 ABS / DUKE R 690	X	X
3	ROYAL ENFIELD	CONTINENTAL 650	X	X
4	TVS	APACHE 310	X	X
5	YAMAHA	XT 660 R / XTZ TENERE 660 ABS	X	X

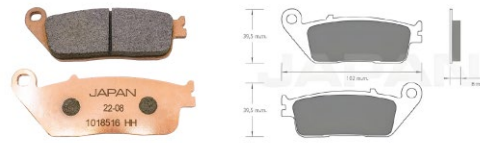

Cód:1018516

HIGH PERFORMANCE HH

Cód. original: 43082-0165

No	MARCA	APLICACIONES	D	T
1	BMW	C 650 GT	X	X
2	HONDA	CBR 300 R / CBR 500 RAA	X	X
3	HONDA	CB 650 R / NC 750 / CBF 1000	X	X
4	KAWASAKI	VERSYS 300 / KLE 650 VERSYS	X	X
5	SUZUKI	VL 1500 L5 L6	X	X
6	TRIUMPH	TIGER 800 XC	X	X

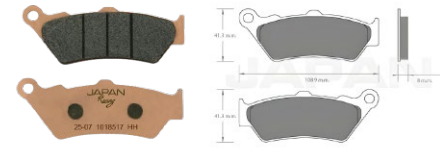

Cód:1018517

HIGH PERFORMANCE HH

Cód. original: 34218534821

No	MARCA	APLICACIONES	D	T
1	BMW	G 650	X	X
2	BMW	R 1200 GS / R 1200 RT / K 1600 GTL	X	X
3	DUCATI	DIAVEL / DIAVEL ABS / DIAVEL STRADA	X	X
4	HARLEY DAVIDSON	XG 750 STREET ROD	X	X
5	KTM	ENDURO 690 / ENDURO R 690	X	X
6	YAMAHA	XT 660 R	X	X

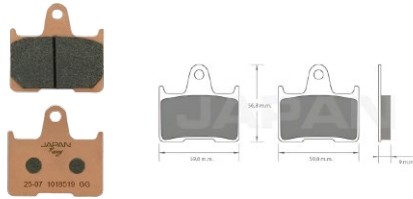

Cód:1018519

HIGH PERFORMANCE GG

Cód. original: 69100-18810

No	MARCA	APLICACIONES	D	T
1	HARLEY DAVIDSON	XL 883 N SPORTSTER IRON / XL 1200 CB	X	X
2	HARLEY DAVIDSON	XL 883 SUPER LOW / XL 1200	X	X
3	HARLEY DAVIDSON	XL 1200 C / CA / XL 1200 T / V / X	X	X
4	HONDA	VT 750 CS SHADOW	X	X
5	KAWASAKI	ZX 1400	X	X
6	SUZUKI	GSXR 600 / GSXR 750	X	X
7	SUZUKI	GSF BANDIT 650/650A ABS /650S ABS /SA	X	X



Cód:1018520

HIGH PERFORMANCE HH

Cód. original: 06455-MEL-D22

No	MARCA	APLICACIONES	D	T
1	HONDA	CB 400 AD / CBR 600 RA / CBR 600 RAA	X	X
2	HONDA	CBR 600 RRA / VFR 800 F	X	X
3	HONDA	VFR 800 FD / VFR 800 X	X	X
4	HONDA	CBR 1000 RAA / CBR 1000 RR	X	X
5	HONDA	CBR 1000 RR FIREBLADE	X	X

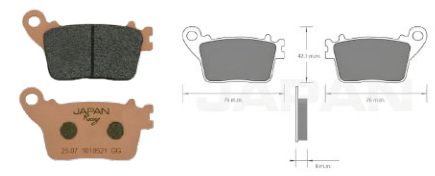

Cód:1018521

HIGH PERFORMANCE GG

Cód. original: 06435-MEL-D23

No	MARCA	APLICACIONES	D	T
1	HONDA	CB 600 F / CBR 600 RR / CBR 1000 RR	X	X
2	KAWASAKI	ZX 636 NINJA / ZX 1000 NINJA	X	X
3	SUZUKI	GSXR 600 / GSXR 750 / GSXR 1000 R A	X	X
4	YAMAHA	YZF R6 / YZF R1 M / YZF R1 S	X	X
5			X	X



Cód:1018522

HIGH PERFORMANCE GG

Cód. original: 06435-KRN-711

No	MARCA	APLICACIONES	D	T
1	HONDA	CRF 150 R	X	X
2	HONDA	CRF 250 F	X	X
3	HONDA	CRF 450 R	X	X
4	KOVE MOTO	RALLY 450	X	X
5			X	X

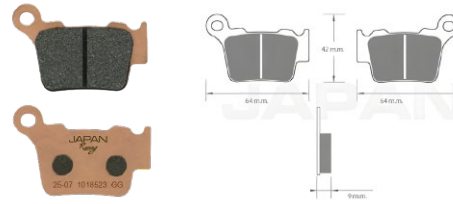

Cód:1018523

HIGH PERFORMANCE GG

Cód. original: 54813090000

No	MARCA	APLICACIONES	D	T
1	HUSABERG	FE 450	X	X
2	HUSQVARNA	FC 250	X	X
3	KTM	EXC 250 F SIX DAYS / SX 250	X	X
4	KTM	SX 250 F / EXC 300 SIX DAYS	X	X
5	KTM	EXC 350 F SIX DAYS / SX 450 F	X	X

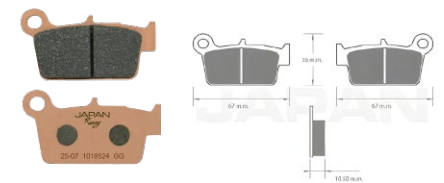

Cód:1018524

HIGH PERFORMANCE GG

Cód. original: 1C3-W0046-BD

No	MARCA	APLICACIONES	D	T
1	KAWASAKI	KX 250 F / KX 450 F	X	X
2	SUZUKI	RMZ 250	X	X
3	YAMAHA	WR 250 F / WR 250 X	X	X
4	YAMAHA	YZ 250 / WR 450 F	X	X
5	YAMAHA	YZ 450 F	X	X

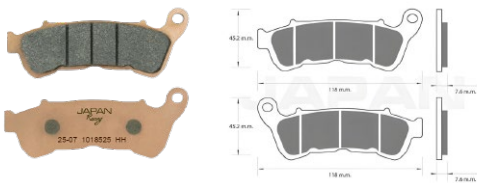

Cód:1018525

HIGH PERFORMANCE HH

Cód. original: 06435-MET-651

No	MARCA	APLICACIONES	D	T
1	HONDA	CBR 250 RA / CBF 600 / SW T 600	X	X
2	HONDA	SILVER WING 600 GT ABS	X	X
3	HONDA	NT 700 V DEAUVILLE / VT 750 SHADOW	X	X
4	HONDA	VFR 800 X CROSSRUNNER / CB 1100	X	X
5	HONDA	VFR 1200 X CROSSRUNNER	X	X

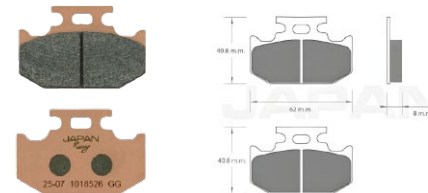

Cód:1018526

HIGH PERFORMANCE GG

Cód. original: 5XT-W0046-50

No	MARCA	APLICACIONES	D	T
1	KAWASAKI	KX 500 / KLX 650 R	X	X
2	SUZUKI	DR 650	X	X
3	YAMAHA	WR 250 / XT X 250 X / XTZ 250 X	X	X
4	YAMAHA	YX E 70 WDB / YX M 700 P VIKING	X	X
5	YAMAHA	YX R 7 FH RHINO	X	X

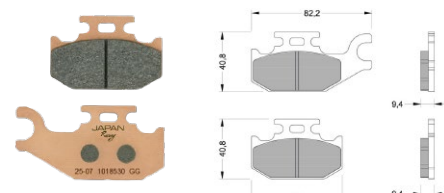

Cód:1018530

HIGH PERFORMANCE GG

Cód. original: 42-9516-001

No	MARCA	APLICACIONES	D	T
1	CAN-AM	COMMANDER MAX 1000 DPS	X	X
2	CAN-AM	MAVERICK 1000 XMR	X	X
3	CAN-AM	MAVERICK MAX 1000 XRS - DPS	X	X
4	SUZUKI	UX 125 / UX 150	X	X
5	YAMAHA	YFM 400 FG	X	X



PASTILLAS DE FRENO

JAPAN Racing



JAPAN

Frenos de Alto Desempeño

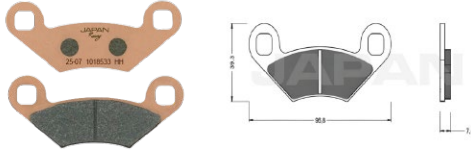

Cód:1018533

HIGH PERFORMANCE GG

Cód. original: 1910036

No	MARCA	APLICACIONES	D	T
1	POLARIS	SPORTSMAN TOURING 500 (11-14)	X	
2	POLARIS	SPORTSMAN 570 6X6 TRACTOR	X	
3	POLARIS	SPORTSMAN 570 EFI X2	X	
4	POLARIS	TOURING TRACTOR EFI EPS	X	
5	POLARIS	SPORTSMAN 800 6X6 BIG BOSS (09-13)	X	
6				

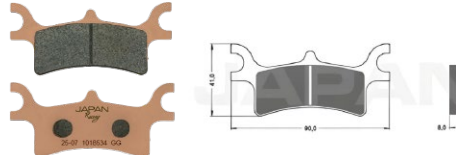

Cód:1018534

HIGH PERFORMANCE GG

Cód. original: 1910683

No	MARCA	APLICACIONES	D	T
1	POLARIS	MAGNUM 325/330/2x4/4x4/Freedom/HDS	X	
2	POLARIS	TRAIL BLAZER 330 / BOSS 330	X	
3	POLARIS	SPORTSMAN 400/450/500/600/700/800	X	
4	POLARIS	SPORTSMAN 800 6X6 / MV 700	X	
5				
6				

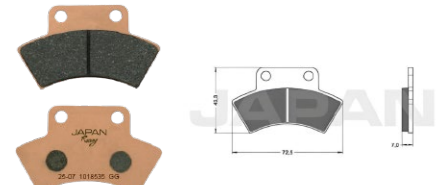

Cód:1018535

HIGH PERFORMANCE GG

Cód. original: 1910032

No	MARCA	APLICACIONES	D	T
1	POLARIS	XPLOER 300 4X4 / XPRESS 300 2X4	X	
2	POLARIS	BIG BOSS 250 4X6 / 300 6X6 / 500 6X6	X	
3	POLARIS	BLAZER 250 / BOSS 250 2X4 - 4X4	X	
4	POLARIS	MAGNUM 425 2X4 - 4X4 - 6X6	X	
5				
6				

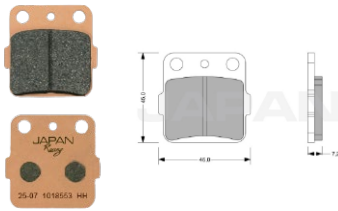

Cód:1018553

HIGH PERFORMANCE HH

Cód. original: 06435-HA5-405

No	MARCA	APLICACIONES	D	T
1	HONDA	TRX 250	X	
2	HONDA	CRF 150 RB	X	
3	HONDA	FOURTRAX	X	
4	YAMAHA	ATV YFS 200	X	
5				
6				

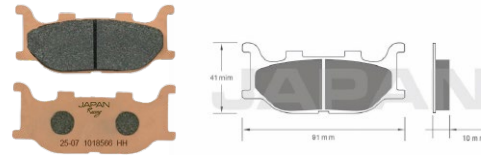

Cód:1018566

HIGH PERFORMANCE HH

Cód. original: 5VU-W0045-00

No	MARCA	APLICACIONES	D	T
1	YAMAHA	V STAR 250	X	
2	YAMAHA	XV 250 VIRAGO	X	
3	YAMAHA	FZ 6	X	
4	YAMAHA	XVS 250 DRAG STAR / XJ 6 N	X	
5	YAMAHA	XJ 6 DIVERSION 600 / V STAR 1100	X	
6	YAMAHA	DRAG STAR 1100	X	

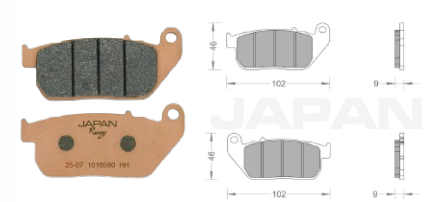

Cód:1018580

HIGH PERFORMANCE HH

Cód. original: 42831-04

No	MARCA	APLICACIONES	D	T
1	HARLEY D.	XL 1200 CB (14-19)	X	
2	HARLEY D.	XL 1200 L SPORTSTER LOW (07-11)	X	
3	HARLEY D.	XL 1200 XS FORTY EIGHT (10-13)	X	
4	HARLEY D.	XL 1200 CUSTOM 110TH ANNIVERSARY	X	
5				
6				

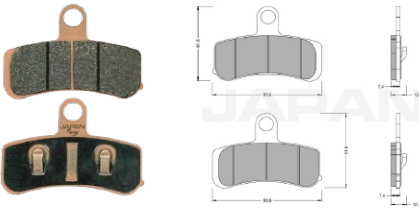

Cód:1018590

HIGH PERFORMANCE HH

Cód. original: 44082-08

No	MARCA	APLICACIONES	D	T
1	HARLEY D.	FXDB DYNA STREET BOB 1584 (08-13)	X	
2	HARLEY D.	FXST SOFTAIL STANDARD (08-14)	X	
3	HARLEY D.	FLSTF FAT BOY 1690 (12-14)	X	
4	HARLEY D.	FXDB DYNA STREET BOB 1690 (14-20)	X	
5				
6				

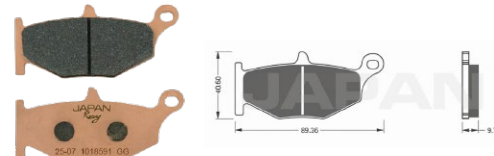

Cód:1018591

HIGH PERFORMANCE GG

Cód. original: 69100-15820

No	MARCA	APLICACIONES	D	T
1	SUZUKI	GSR 600 / GSR 750 / GSX R 1000	X	
2	SUZUKI	V STROM 1050 / V STROM 1050 XT	X	
3	SUZUKI	GSX 1300 R HAYABUSA / B KING 1300	X	
4	SUZUKI	HAYABUSA 1300 ABS / HAYABUSA 1300 LTD	X	
5	SUZUKI	HAYABUSA 1300 LTD ABS	X	

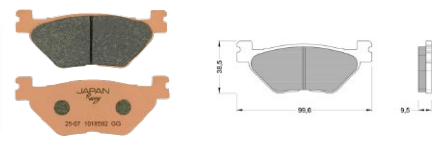

Cód:1018592

HIGH PERFORMANCE GG

Cód. original: 3D8-25806-00

No	MARCA	APLICACIONES	D	T
1	YAMAHA	STRYKER BULLET COWL	X	
2	YAMAHA	TDM 900 ABS / BOLT (BP67) ABS	X	
3	YAMAHA	V STAR 950 / FJR 1300 / V STAR 1300	X	
4	YAMAHA	MIDNIGHT STAR / V MAX 1700	X	
5	YAMAHA	SUPER TENERE 1200 ABS	X	

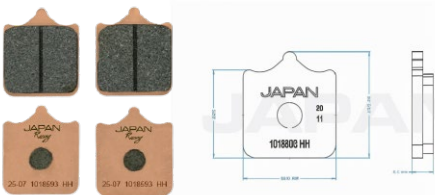

Cód:1018593

HIGH PERFORMANCE HH

Cód. original: 07BB3396

No	MARCA	APLICACIONES	D	T
1	APRILIA	RSV 1000 / RSV 1000 R	X	
2	BENELLI	TRX 502 / BN 600 / TNT 600 / TNT 899	X	
3	BIMOTA	DB 10 / DBSR / DB12 / DB9	X	
4	DUCATI	749 / R 748 / 996 RS / MONSTER S4RS	X	
5	KTM	DUKE 690 / SUPERMOTO 950	X	
6	TRIUMPH	SPEED TRIPLE	X	

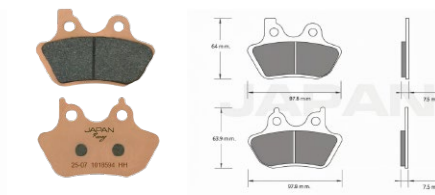

Cód:1018594

HIGH PERFORMANCE HH

Cód. original: 44082-00E

No	MARCA	APLICACIONES	D	T
1	HARLEY DAVIDSON	FLHX STREET GLIDE	X	
2	HARLEY DAVIDSON	FLRT ROAD GLIDE	X	
3	HARLEY DAVIDSON	FXST SOFTAIL STANDARD	X	

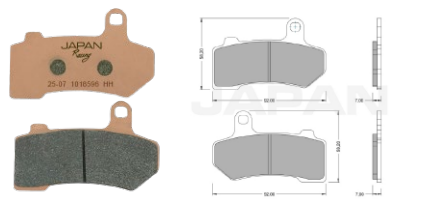

Cód:1018596

HIGH PERFORMANCE HH

Cód. original: 41852-08B

No	MARCA	APLICACIONES	D	T
1	HARLEY DAVIDSON	FLHR ROAD KING	X	
2	HARLEY DAVIDSON	FLHTK ELECTRA GLIDE ULTRA LTD	X	
3	HARLEY DAVIDSON	FLHX STREET GLIDE OCCASION	X	



PASTILLAS DE FRENO

JAPAN Racing



JAPAN Frenos de Alto Desempeño

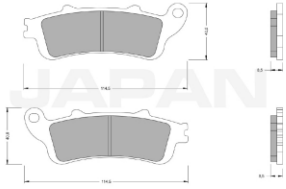

Cód:1018598

HIGH PERFORMANCE HH

Cód. original: 06435-MCH-006

No	MARCA	APLICACIONES	D	T
1	HONDA	GL1800/GL1800 A/GL1800B GOLDWING	X	X
2	HONDA	SILVERWING 400 / 600 (03-08)	X	
3	KAWASAKI	VULCAN 650	X	
4	HONDA	VTX 1800 S	X	
5				
6				

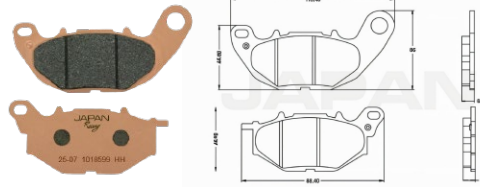

Cód:1018599

HIGH PERFORMANCE HH

Cód. original: B74-F3317-00

No	MARCA	APLICACIONES	D	T
1	YAMAHA	YZF R3	X	X
2	YAMAHA	MT 25	X	
3	YAMAHA	YZF R25	X	
4	YAMAHA	X MAX 300	X	
5	YAMAHA	MT 03	X	
6				

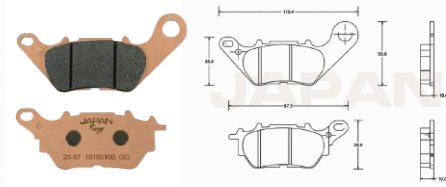

Cód:10185100

HIGH PERFORMANCE GG

Cód. original: 1WD-25806-00

No	MARCA	APLICACIONES	D	T
1	YAMAHA	YZF R3	X	X
2	YAMAHA	MT 25	X	
3	YAMAHA	YZF R25	X	
4	YAMAHA	X MAX 300	X	
5	YAMAHA	MT 03	X	
6				

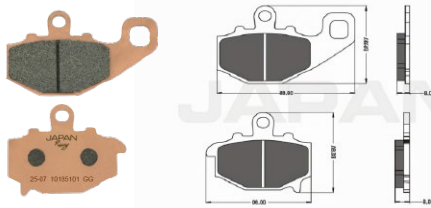

Cód:10185101

HIGH PERFORMANCE GG

Cód. original: 43082-0004

No	MARCA	APLICACIONES	D	T
1	CF MOTO	650 NK - 7B		X
2	KAWASAKI	NINJA ZX-6R		X
3	KAWASAKI	VERSYS 650 / ABS		X
4	KAWASAKI	NINJA ZX-10R / Z 1000		X
5				
6				

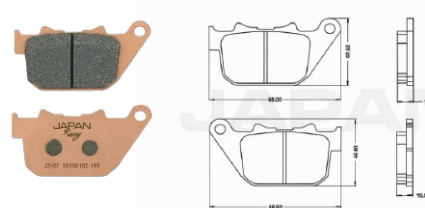

Cód:10185102

HIGH PERFORMANCE HH

Cód. original: 42029-07

No	MARCA	APLICACIONES	D	T
1	HARLEY D.	XL 1200 R / C / L / N / X / V		X
2	HARLEY D.	XR 1200 / X		X
3	HARLEY D.	XL 883 C / L / N / R		X
4	HARLEY D.	XLH 883		X
5				
6				

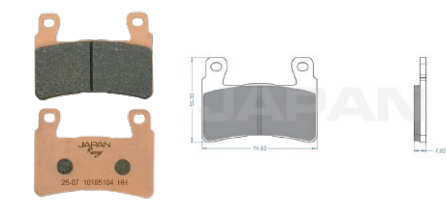

Cód:10185104

HIGH PERFORMANCE HH

Cód. original: 06455-MBW-305

No	MARCA	APLICACIONES	D	T
1	HARLEY D.	FATBOY 1689 (15-17) / SOFTAIL STD 1745	X	X
2	HARLEY D.	HERITAGE CLASSIC 1750 (18-22) / FXLR	X	X
3	HONDA	GOLDWING 1800 (14-17)	X	
4	HONDA	CB 1300 A/F/P/S SUPER BOLD OR	X	
5				
6				

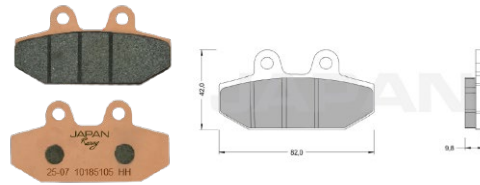

Cód:10185105

HIGH PERFORMANCE GG

Cód. original: 41300197

No	MARCA	APLICACIONES	D	T
1	HARLEY D.	FLHC HERITAGE CLASSIC 107 (18-22)	X	X
2	HARLEY D.	FLSB SPORTS GLIDE 1750	X	
3	HARLEY D.	FXLR LOW RIDER 1750	X	
4	HARLEY D.	FLFBS FAT BOY 114 (18-23)	X	
5				
6				

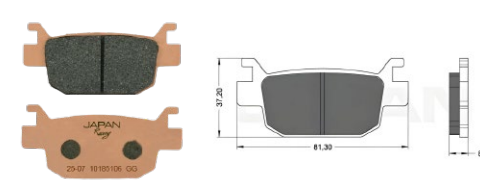

Cód:10185106

HIGH PERFORMANCE GG

Cód. original: 55120P100000

No	MARCA	APLICACIONES	D	T
1	BENELLI	TNT 25 N / TNT 250 / TNT 300	X	X
2	BENELLI	TRK 251 / TRK 502	X	
3	BENELLI	LEONCINO 250	X	
4	BENELLI	302 R / 302 S	X	
5	BENELLI	BN 302	X	
6	BENELLI	IMPERIAL 400	X	
7	BENELLI	LEONCINO 500	X	

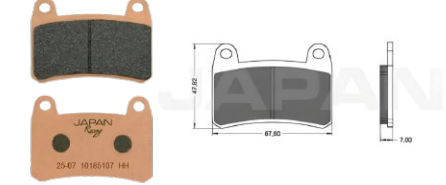

Cód:10185107

HIGH PERFORMANCE HH

Cód. original: 45120P100000

No	MARCA	APLICACIONES	D	T
1	BENELLI	BN 251 / BN 302	X	X
2	BENELLI	TNT 249 / TNT 25 N / TNT 300	X	
3	BENELLI	TRK 251	X	
4	BENELLI	LEONCINO 250	X	
5	BENELLI	302 R / 302 S	X	
6	BENELLI	402 S	X	

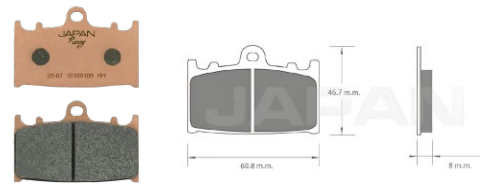

Cód:10185108

HIGH PERFORMANCE HH

Cód. original: 43082-1110

No	MARCA	APLICACIONES	D	T
1	KAWASAKI	ZZR 600 E6F	X	
2	KAWASAKI	VERSYS 1000	X	
3	KAWASAKI	VULCAN 1700 VAQUERO ABS	X	
4	SUZUKI	GSR 600 / ABS	X	
5	SUZUKI	SV 65 A	X	

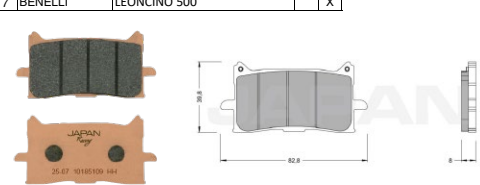

Cód:10185109

HIGH PERFORMANCE HH

Cód. original: 06455-K94-T01

No	MARCA	APLICACIONES	D	T
1	HONDA	X ADV 750	X	
2	HONDA	AFRICA TWIN 1100	X	
3	HONDA	CB 1000 HORNET	X	
4	HONDA	CB 300	X	
5	HONDA	CB 650 R	X	



Cód:10185110

HIGH PERFORMANCE HH

Cód. original: 42298-08

No	MARCA	APLICACIONES	D	T
1	HARLEY D.	FLSTF FAT BOY (08-11)	X	X
2	HARLEY D.	FXDB DYNASTREET BOB 1584 (08-13)	X	X
3	HARLEY D.	FLD SWITCH BACK (12-16)	X	
4	HARLEY D.	FXDB DYNASTREET BOB 1690 (14-20)	X	X



PASTILLAS DE FRENO

JAPAN Racing



JAPAN

Frenos de Alto Desempeño

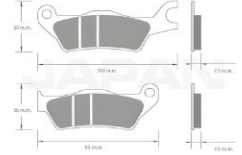
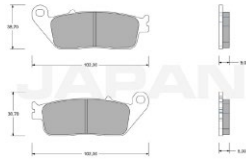

Cód:10185111

HIGH PERFORMANCE HH

Cód. original: 06435-MW3-A91

No	MARCA	APLICACIONES	D	T
1	HONDA	CBR 300 R	X	X
2	HONDA	CB 350 H'NESS / X ADV 350	X	
3	SUZUKI	V STROM 800	X	
4	KOVE MOTO	510 F / 510 X / 800 X	X	
5				
6				

Cód:10185112

HIGH PERFORMANCE HH

Cód. original: 107-A486-49

No	MARCA	APLICACIONES	D	T
1	APRILIA	RSV 1100 TUONO V4 RR	X	
2	DUCATI	HYPERMOTARD 960 SP / PANIGALE V4R 998	X	
3	HONDA	CBR 1000 RR SP / CBR 1000 RR-R FIREBLADE	X	
4	SUZUKI	GSX-S 1000 / ABS	X	
5				
6				

Cód:10185113

HIGH PERFORMANCE HH

Cód. original: 06455-KCC-842

No	MARCA	APLICACIONES	D	T
1	SUZUKI	GIXXER 250 SF	X	
2	SUZUKI	V STROM 250 SX (23-25)	X	
3				
4				
5				
6				

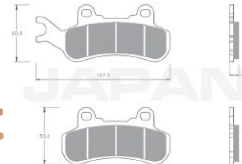
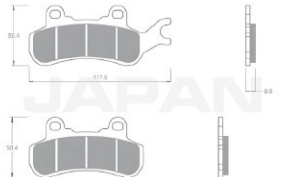
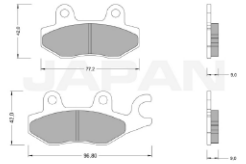
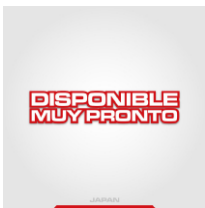

Cód:10185114

HIGH PERFORMANCE HH

Cód. original: 06455-GCR-016L

No	MARCA	APLICACIONES	D	T
1	KAWASAKI	NINJA 400	X	X
2	KAWASAKI	Z 500 NINJA	X	X
3	KAWASAKI	W 800	X	
4	TRIUMPH	TIGER 1050	X	
5				
6				

Cód:10185115

HIGH PERFORMANCE HH

Cód. original: 715900379

No	MARCA	APLICACIONES	D	T
1	CAN AM	DEFENDER XT 799 (IZQUIERDA)	X	
2	CAN AM	DEFENDER DPS 976 (IZQUIERDA)	X	
3	CAN AM	DEFENDER XT 976 (IZQUIERDA)	X	
4	CAN AM	MAVERICK X3 (IZQUIERDA)	X	
5	CAN AM	MAVERICK X3 TURBO (IZQUIERDA)	X	
6				

Cód:10185116

HIGH PERFORMANCE HH

Cód. original: 715900387

No	MARCA	APLICACIONES	D	T
1	CAN AM	DEFENDER XT 799 (DERECHA)	X	
2	CAN AM	DEFENDER DPS 976 (DERECHA)	X	
3	CAN AM	DEFENDER XT 976 (DERECHA)	X	
4	CAN AM	MAVERICK X3 (DERECHA)	X	
5	CAN AM	MAVERICK X3 TURBO (DERECHA)	X	
6				

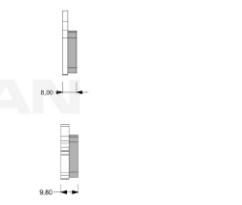
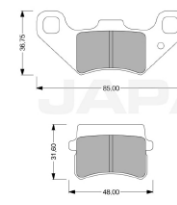
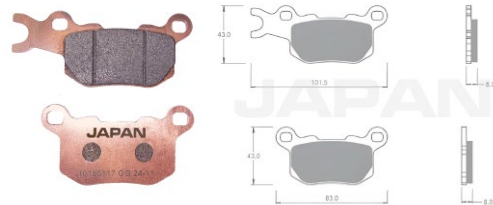

Cód:10185117

HIGH PERFORMANCE GG

Cód. original: N/A

No	MARCA	APLICACIONES	D	T
1	CAN AM	DEFENDER XT 799 (DERECHA)	X	
2	CAN AM	DEFENDER DPS 976 (DERECHA)	X	
3	CAN AM	DEFENDER XT 976 (DERECHA)	X	
4	CAN AM	MAVERICK X3 (DERECHA)	X	
5	CAN AM	MAVERICK X3 TURBO (DERECHA)	X	
6				

Cód:10185118

HIGH PERFORMANCE GG

Cód. original: N/A

No	MARCA	APLICACIONES	D	T
1	CAN AM	DEFENDER XT 799 (IZQUIERDA)	X	
2	CAN AM	DEFENDER DPS 976 (IZQUIERDA)	X	
3	CAN AM	DEFENDER XT 976 (IZQUIERDA)	X	
4	CAN AM	MAVERICK X3 (IZQUIERDA)	X	
5	CAN AM	MAVERICK X3 TURBO (IZQUIERDA)	X	
6				

Cód:10185119

HIGH PERFORMANCE GG

Cód. original: 5543005

No	MARCA	APLICACIONES	D	T
1	APOLLO	FOURTRAX AGA 4 / VRX 110 F	X	
2	APOLLO	MINI COMMANDER / VRX 125 AGA	X	
3	ITALIKA	ATV 150	X	
4	ITALIKA	ATV 150 SPORT	X	
5				
6				

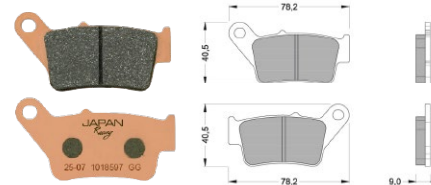
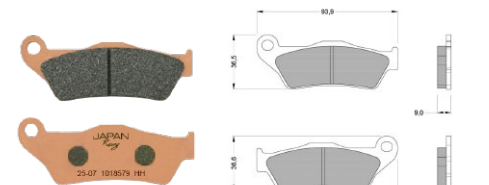
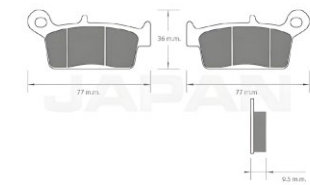

Cód:1018529

HIGH PERFORMANCE GG

Cód. original: 06455-MAK-003

No	MARCA	APLICACIONES	D	T
1	---	---	X	
2	---	---	X	
3	---	---	X	
4	---	---	X	
5				
6				

Cód:1018579

HIGH PERFORMANCE HH

Cód. original: 34-21-2-314-947

No	MARCA	APLICACIONES	D	T
1	BAJAJ	PULSAR NS 400	X	
2	BAJAJ	PULSAR N 250 GT	X	
3	BAJAJ	DOMINAR 400 V1	X	
4				
5				
6				

Cód:1018597

HIGH PERFORMANCE GG

Cód. original: 36DH4174

No	MARCA	APLICACIONES	D	T
1	BAJAJ	NS 400	X	
2				
3				
4				
5				
6				



PASTILLAS DE FRENO JAPAN Racing



JAPAN

Frenos de Alto Desempeño

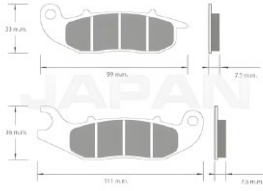

Cód:1018587

HIGH PERFORMANCE HH

Cód. original: 06451-KZZ-901

No	MARCA	APLICACIONES	D	T
1	APRILIA	SR GT 200	X	
2	YAMAHA	XTZ 150 CROSSER / CROSSER ABS	X	
3	YAMAHA	XTZ 250 / ABS	X	
4	VENTO	SCREAMER SPORTIVO 250	X	
5				
6				

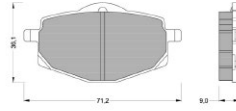

Cód:10185103

HIGH PERFORMANCE HH

Cód. original: 1UY-W0045-00

No	MARCA	APLICACIONES	D	T
1	YAMAHA	XT 600 E		X
2	YAMAHA	DT 200 R	X	X
3	YAMAHA	XT 350	X	
4				
5				
6				

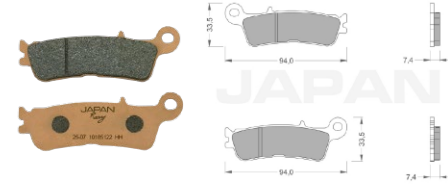

Cód:10185122

HIGH PERFORMANCE HH

Cód. original: N/A

No	MARCA	APLICACIONES	D	T
1	YAMAHA	YZ 125 2T MONSTER (22-25)	X	
2	YAMAHA	YZ 450 F MONSTER (21-24)	X	
3	YAMAHA	YZ 450 F (21-24) / YZ 450 FX (21-24)	X	
4	YAMAHA	YZ 250 F (20-25)	X	
5				
6				



- Bandas de freno *Premium*
- Pastillas **JAPAN** *Premium Organics*
- Pastillas **JAPAN** *Premium Semimetallics*
- Pastillas **JAPAN** *Racing*
- Pastillas **JAPAN** *COMPETITION PRO*
- Pastillas **JAPAN** *Bike*
- Maniguetas
- Bases de Espejo
- Conjunto Base + Manigueta
- Discos de Freno
- Reposapiés
- Ejes de Rueda
- Ejes de Cambio
- Varillas de Freno
- Cuñas
- Pedales de Encendido
- Pedales de Cambio
- Pedales de Freno
- Tornillos
- Resortes de Banda
- Otros Productos
- Rines **Murelli**

Industrias Japan S.A



INDUSTRIAS JAPAN S.A.
Fabricantes de partes para motocicletas

Live safely





CATÁLOGO DE PRODUCTOS

2026



JAPAN
INDUSTRIAS
JAPAN S.A.

www.industriasjapan.com



INDUSTRIAS JAPAN S.A.

Fabricantes de partes para motocicletas

Live safely



PASTILLAS DE FRENO JAPAN Bike



JAPAN

Frenos de Alto Desempeño

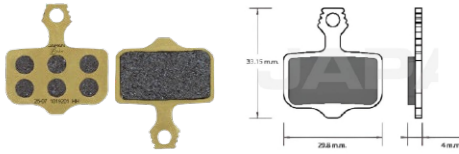

Cód:1019201

HIGH PERFORMANCE HH

Cód. original: 00-5315-035-020

No	MARCA	APLICACIONES	D	T
1	AVID	DB 3	X	X
2	AVID	DB 5	X	X
3	AVID	ELIXIR 1	X	X
4	SRAM	X0 / XX / YK-6	X	X
5				
6				

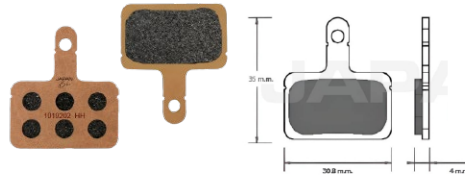

Cód:1019202

HIGH PERFORMANCE HH

Cód. original: 22D90001077

No	MARCA	APLICACIONES	D	T
1	SHIMANO	NEXAVE	X	X
2	SHIMANO	ACERA	X	X
3	TEKTRO	AURIGA	X	X
4	ALONGA	HJ-LATTO	X	X
5				
6				

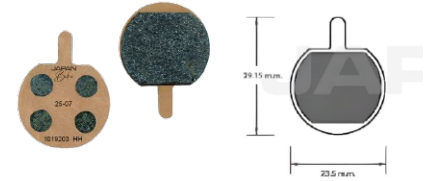

Cód:1019203

HIGH PERFORMANCE HH

Cód. original: 98-28142

No	MARCA	APLICACIONES	D	T
1	APSE ARTEK	ADC 08 / 09 / 10	X	X
2	BENGAL	ARES / HELIX	X	X
3	HAYES	MX 2 / 3 / 4 / 5	X	X
4	QUAD	QHD AXIS / TORK	X	X
5				
6				

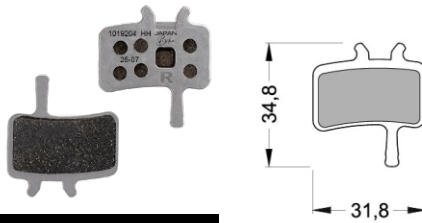

Cód:1019204

HIGH PERFORMANCE HH

Cód. original: 5315001020

No	MARCA	APLICACIONES	D	T
1	SRAM/AVID	JUICY	X	X
2	SRAM/AVID	BB 7	X	X
3	CLARKS	CMD 15	X	X
4	ALHONGA	DSK 950	X	X
5				



Cód: 1019205

HIGH PERFORMANCE HH

Cód. original: 71100000000

No	MARCA	APLICACIONES	D	T
1	OZONO B.	PATINETA ELÉCTRICA	X	X
2	YINXING	PATINETA ELÉCTRICA	X	X
3	KUGOO G2 P	PATINETA ELÉCTRICA	X	X
4	ON TRAIL	ALUMINIO MTB	X	X
5				



Cód:1019206

HIGH PERFORMANCE HH

Cód. original: N/A

No	MARCA	APLICACIONES	D	T
1	SHIMANO	R-9170	X	X
2	SHIMANO	BR-M9100	X	X
3	SHIMANO	R-7070 / R-8070	X	X
4	SHIMANO	RS-405 / RS-505 / RS-805	X	X
5				
6				
7				



Cód:1019208

HIGH PERFORMANCE HH

Cód. original: 5315001020

No	MARCA	APLICACIONES	D	T
1	SHIMANO	BR-M640	X	X
2	SHIMANO	BR-MT520	X	X
3	SHIMANO	BR-MT420	X	X
4	SHIMANO	BR-M8120	X	X
5				



- Bandas de freno *Premium*
- Pastillas **JAPAN** *Premium Organics*
- Pastillas **JAPAN** *Premium Semimetallics*
- Pastillas **JAPAN** *Racing*
- Pastillas **JAPAN** *COMPETITION PRO*
- Pastillas **JAPAN** *Bike*
- Maniguetas
- Bases de Espejo
- Conjunto Base + Manigueta
- Discos de Freno
- Reposapiés
- Ejes de Rueda
- Ejes de Cambio
- Varillas de Freno
- Cuñas
- Pedales de Encendido
- Pedales de Cambio
- Pedales de Freno
- Tornillos
- Resortes de Banda
- Otros Productos
- Rines **Murelli**

Industrias Japan S.A



INDUSTRIAS JAPAN S.A.
Fabricantes de partes para motocicletas

Live safely



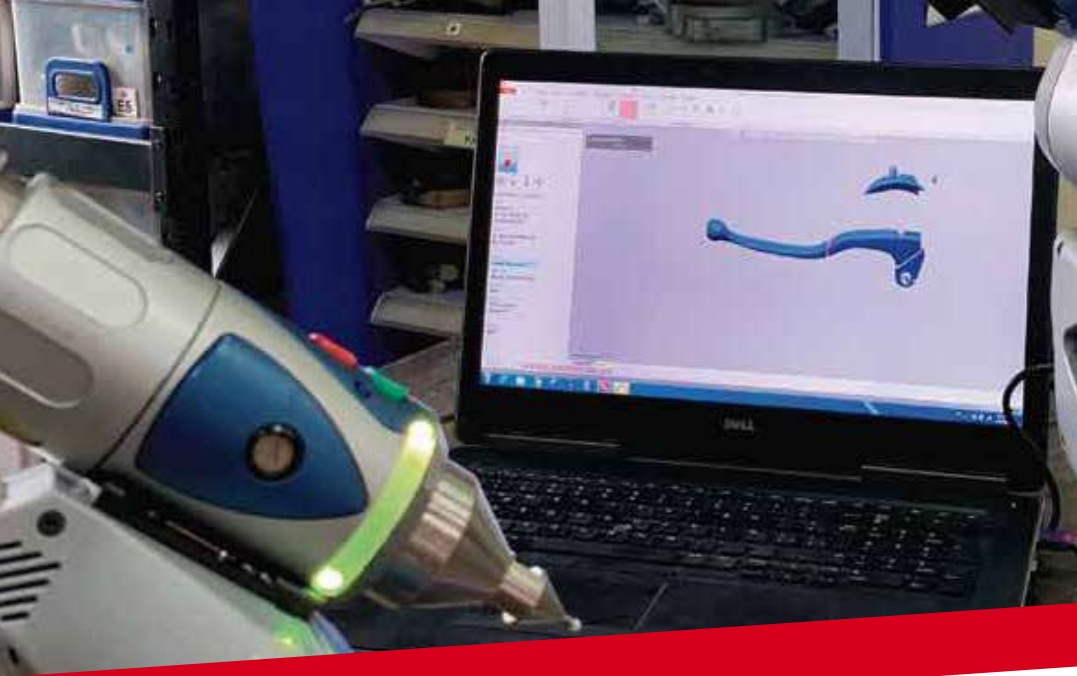

MANIGUETAS

ALUMINIO DE
EXCELENTE
CALIDAD

1

Fabricadas en aleaciones de aluminio bajo controles estrictos de composición química garantizando la resistencia mecánica y flexibilidad requerida para este tipo de piezas.

2

Configuración y dimensiones debidamente controladas para asegurar el correcto ensamble en la motocicletas y la ergonomía en su uso.

3

Dependiendo del modelo y referencias, se ofrecen con terminado en aluminio brillante o acabado en pintura negra electrostática.



Para el desarrollo de las maniguetas, así como de otros productos en Aluminio, **INDUSTRIAS JAPAN S.A** cuenta con sistemas CAD/CAM/CAE para diseño y fabricación de los moldes, así como la simulación para el proceso de inyección a presión. (DIE CASTING TECHNOLOGY).

El mecanizado de estos productos se realiza en máquinas automáticas de alta productividad y estabilidad.

En el laboratorio de **INDUSTRIAS JAPAN S.A**, se realizan pruebas de resistencia mecánica a las maniguetas bajo estándares japoneses que garantizan la seguridad de estos elementos.



MANIGUETAS



JAPAN
Frenos de Alto Desempeño

MANIGUETAS



JAPAN
Frenos de Alto Desempeño



Cód. **101101**

IZQUIERDA

Cód. original: 2H0-83912-20

No	MARCA	APLICACIONES	IZO	DER
1	YAMAHA	DT 100 / RX 100 / RX 100 INDU / RX 100 JAPON	X	
2	YAMAHA	LIBERO 110 / DT 125 D / DT 125 DS	X	
3	YAMAHA	DTK 125 / DT 175 / DT 175 C / DT 175 D	X	
4	YAMAHA	DT 175 E / DT 175 F / DTK 175	X	
5				



Cód. **101102**

DERECHA

Cód. original: 2H0-83922-20

No	MARCA	APLICACIONES	IZO	DER
1	YAMAHA	DT 100 / RX 100 / RX 100 INDU / RX 100 JAPON		X
2	YAMAHA	LIBERO 110 / DTK 125 / DT 175 / DT 175 C	X	
3	YAMAHA		X	
4	YAMAHA		X	
5				



Cód. **101103**

IZQUIERDA

Cód. original: 57620-48701

No	MARCA	APLICACIONES	IZO	DER
1	SUZUKI	TS 100	X	
2	SUZUKI	AX 115	X	
3	SUZUKI	TS 125 CR	X	
4	SUZUKI	TS 125 ER	X	
5	SUZUKI	TS 185 ER	X	



Cód. **101104**

DERECHA

Cód. original: 57420-48700

No	MARCA	APLICACIONES	IZO	DER
1	SUZUKI	TS 100 / AX 115		X
2	SUZUKI	TS 125 CR		X
3	SUZUKI	TS 125 ER		X
4	SUZUKI	TS 125 X		X
5	SUZUKI	TS 185 ER		X



Cód. **101105**

IZQUIERDA

Cód. original: 57621-02410

No	MARCA	APLICACIONES	IZO	DER
1	SUZUKI	FZ 50	X	
2				
3				
4				
5				



Cód. **101106**

DERECHA

Cód. original: 57421-02410

No	MARCA	APLICACIONES	IZO	DER
1	SUZUKI	FZ 50		X
2				
3				
4				
5				



Cód. **101108**

IZQUIERDA

Cód. original: 53178-399-700

No	MARCA	APLICACIONES	IZO	DER
1	HONDA	XL 100	X	
2	HONDA	XL 185	X	
3	SIGMA	SG 100	X	
4	SIGMA	SG 125	X	
5				



Cód. **101109**

DERECHA

Cód. original: 53175-399-700

No	MARCA	APLICACIONES	IZO	DER
1	HONDA	XL 100		X
2	HONDA	XL 185		X
3				
4				
5				



Cód. **1011010**

IZQUIERDA

Cód. original: 57620-49101

No	MARCA	APLICACIONES	IZO	DER
1	SUZUKI	TR 125	X	
2	SUZUKI	TS 125 X CR	X	
3	SUZUKI	TS 125 Z	X	
4	SUZUKI	TS 185 ER	X	
5	SUZUKI	DR 250 / DR 500	X	



Cód. **1011011**

DERECHA

Cód. original: 57420-48700

No	MARCA	APLICACIONES	IZO	DER
1	SUZUKI	TS 185 ER		X
2				
3				
4				
5				



Cód. **1011012**

DERECHA

Cód. original: 53175-090-700

No	MARCA	APLICACIONES	IZO	DER
1	HONDA	C 70		X
2				
3				
4				
5				



Cód. **1011013**

DERECHA

Cód. original: 46092-1013

No	MARCA	APLICACIONES	IZO	DER
1	KAWASAKI	AN 80 G2 JOY		X
2	KAWASAKI	NEOMAX 100		X
3	KAWASAKI	MAGIC II 110		X
4	KAWASAKI	CHEER 112		X
5				

MANIGUETAS



JAPAN
Frenos de Alto Desempeño



Cód. 1011014

DERECHA

Cód. original: 4L0-83922-00

No	MARCA	APLICACIONES	IZO	DER
1	YAMAHA	RX 115 S / DT 125 D / DT 125 DS		X
2	YAMAHA	RXZ 135 / DT 175 D / DT 175 E		X
3	YAMAHA	DT 175 F / DTK 175		X
4				
5				



Cód. 1011015

IZQUIERDA

Cód. original: 57621-02420

No	MARCA	APLICACIONES	IZO	DER
1	SUZUKI	ADDRESS 60	X	
2				
3				
4				
5				



Cód. 1011016

DERECHA

Cód. original: 57421-02420

No	MARCA	APLICACIONES	IZO	DER
1	SUZUKI	ADDRESS 60		X
2				
3				
4				
5				



Cód. 1011017

DERECHA

Cód. original: 57421-19114

No	MARCA	APLICACIONES	IZO	DER
1	SUZUKI	FR 80		X
2	SUZUKI	FR 100		X
3				
4				
5				



Cód. 1011018

IZQUIERDA

Cód. original: 57621-27210

No	MARCA	APLICACIONES	IZO	DER
1	SUZUKI	A 80	X	
2	SUZUKI	A 100	X	
3	SUZUKI	AX 100	X	
4				
5				



Cód. 1011019

DERECHA

Cód. original: 57421-27212

No	MARCA	APLICACIONES	IZO	DER
1	SUZUKI	A 80		X
2	SUZUKI	A 100		X
3	SUZUKI	AX 100		X
4				
5				



Cód. 1011020

DERECHA

Cód. original: 122-83922-02

No	MARCA	APLICACIONES	IZO	DER
1	YAMAHA	V 80		X
2				
3				
4				
5				



Cód. 1011021

DERECHA

Cód. original: 57421-39D10

No	MARCA	APLICACIONES	IZO	DER
1	SIGMA	SG 100	X	
2	SIGMA	SG 125	X	
3	SUZUKI	TS 125 CR	X	
4	SUZUKI	TS 125 X CR	X	
5	SUZUKI	TS 125 Z	X	



Cód. 1011022

IZQUIERDA

Cód. original: 2425314

No	MARCA	APLICACIONES	IZO	DER
1	PIAGGIO	PX 150	X	
2				
3				
4				
5				



Cód. 1011023

IZQUIERDA

Cód. original: 2425314

No	MARCA	APLICACIONES	IZO	DER
1	PIAGGIO	PX 150	X	
2				
3				
4				
5				



Cód. 1011024

DERECHA

Cód. original: 53175-KB7-000

No	MARCA	APLICACIONES	IZO	DER
1	HONDA	NXR 125 BROSS		X
2	HONDA	XLR 125		X
3	HONDA	XLR 125 BRASIL		X
4	HONDA	XLR 125 TT		X
5				



Cód. 1011025

IZQUIERDA

Cód. original: 53178-KB7-000

No	MARCA	APLICACIONES	IZO	DER
1	HONDA	XLR 125		X
2	HONDA	XLR 125 BRASIL		X
3	HONDA	XLR 125 TT		X
4				
5				

MANIGUETAS



JAPAN
Frenos de Alto Desempeño



Cód. 1011027

DERECHA

Cód. original: 395-83922-02

No	MARCA	APLICACIONES	IZO	DER
1	YAMAHA	LB 80 CHAPPY		X
2				
3				
4				
5				



Cód. 1011028

DERECHA

Cód. original: 14T-83922-01

No	MARCA	APLICACIONES	IZO	DER
1	YAMAHA	CY 50 JOG		X
2				
3				
4				
5				



Cód. 1011029

IZQUIERDA

Cód. original: 14T-83912-01

No	MARCA	APLICACIONES	IZO	DER
1	YAMAHA	CY 50 JOG	X	
2				
3				
4				
5				



Cód. 1011030

IZQUIERDA

Cód. original: 2T4-83912-01

No	MARCA	APLICACIONES	IZO	DER
1	YAMAHA	CY 50 JOG		X
2				
3				
4				
5				



Cód. 1011031

DERECHA

Cód. original: 2T4-83922-01

No	MARCA	APLICACIONES	IZO	DER
1	YAMAHA	CY 50 JOG		X
2				
3				
4				
5				



Cód. 1011032

IZQUIERDA

Cód. original: 46092-1111

No	MARCA	APLICACIONES	IZO	DER
1	KAWASAKI	KMX 125	X	
2				
3				
4				
5				



Cód. 1011033

DERECHA

Cód. original: 46092-1135

No	MARCA	APLICACIONES	IZO	DER
1	KAWASAKI	KMX 125		X
2	SUZUKI	FD 115 VIVA F.D.		X
3	SUZUKI	BEST 125		X
4				
5				



Cód. 1011034

DERECHA

Cód. original: 46092-1140

No	MARCA	APLICACIONES	IZO	DER
1	KAWASAKI	KDX 125		X
2	KAWASAKI	KLX 150		X
3	KAWASAKI	KLX 250		X
4	KAWASAKI	KLX 250 S		X
5	YAMAHA	XTZ 125 K		X



Cód. 1011035

IZQUIERDA

Cód. original: 46092-1159

No	MARCA	APLICACIONES	IZO	DER
1	KAWASAKI	KDX 125	X	
2				
3				
4				
5				



Cód. 1011036

DERECHA

Cód. original: 4AN-H3922-00

No	MARCA	APLICACIONES	IZO	DER
1	YAMAHA	DT 200 LC		X
2	YAMAHA	DT 200 R		X
3	YAMAHA	DT 200 WR		X
4				
5				



Cód. 1011037

DERECHA

Cód. original: 53175-GR2-010

No	MARCA	APLICACIONES	IZO	DER
1	HONDA	C 90		X
2	HONDA	C 90 E		X
3				
4				
5				



Cód. 1011038

IZQUIERDA

Cód. original: 53178-KCH-900

No	MARCA	APLICACIONES	IZO	DER
1	HONDA	CG 125 ES / CB 250 F	X	
2	HONDA	CG 125 TITAN	X	
3	HONDA	CG 125 TITAN ES	X	
4	HONDA	CG 125 TITAN KS	X	
5	HONDA	CG 125 TITAN KSE	X	

MANIGUETAS



JAPAN
Frenos de Alto Desempeño



Cód. 1011039 DERECHA

Cód. original: 53175-KGA-900

No	MARCA	APLICACIONES	IZO	DER
1	HONDA	CG 125 ES		X
2	HONDA	CG 125 TITAN		X
3	HONDA	CG 125 TITAN KS		X
4	HONDA	CG 125 TITAN KSE		X
5				



Cód. 1011040 IZQUIERDA

Cód. original: 4AN-H3912-00

No	MARCA	APLICACIONES	IZO	DER
1	YAMAHA	DT 200 LC	X	
2	YAMAHA	DT 200 R	X	
3	YAMAHA	DT 200 WR	X	
4				
5				



Cód. 1011041 IZQUIERDA

Cód. original: 23X-83912-00

No	MARCA	APLICACIONES	IZO	DER
1	YAMAHA	YZ 80 / DT 125 / DT 125 D / DT 125 DS	X	
2	YAMAHA	DT 175 D / DT 175 E / DT 175 F / DTK 175	X	
3	YAMAHA	XT 225 / XT 225 SEROW	X	
4				
5				



Cód. 1011042 DERECHA

Cód. original: 55Y-83922-00

No	MARCA	APLICACIONES	IZO	DER
1	YAMAHA	YZ 80 / DT 125 / DT 125 D / DT 125 DS		X
2	YAMAHA	DT 175 D / DT 175 E / DT 175 F		X
3	YAMAHA	DTK 175 / XT 225 / XT 225 SEROW		X
4				
5				



Cód. 1011043 IZQUIERDA

Cód. original: 31A-83912-00

No	MARCA	APLICACIONES	IZO	DER
1	YAMAHA	RX 115 S	X	
2				
3				
4				
5				



Cód. 1011046 IZQUIERDA

Cód. original: 53178-198-900

No	MARCA	APLICACIONES	IZO	DER
1	HERO	CD 100 SPLENDOR	X	
2	HERO	GLAMOUR 125	X	
3	HERO	SPLENDOR / SMART 125	X	
4	HERO	SUPER SPLENDOR 125	X	
5				



Cód. 1011047 DERECHA

Cód. original: 53175-198-900

No	MARCA	APLICACIONES	IZO	DER
1	HERO	CD 100 SPLENDOR		X
2	HONDA	ECO 100		X
3				
4				
5				



Cód. 1011050 DERECHA

Cód. original: 31A-83922-00

No	MARCA	APLICACIONES	IZO	DER
1	YAMAHA	RX 115 S	X	
2				
3				
4				
5				



Cód. 1011051 IZQUIERDA

Cód. original: 53178-MG7-003

No	MARCA	APLICACIONES	IZO	DER
1	HONDA	NXR 125 BROSS	X	
2	HONDA	XL 200	X	
3	HONDA	XR 200	X	
4	HONDA	NX 400 FALCON	X	
5				



Cód. 1011052 DERECHA

Cód. original: 53175-KV2-900

No	MARCA	APLICACIONES	IZO	DER
1	HONDA	XR 125 L / XR 125 L II / XR 150 L / XR 180 C		X
2	HONDA	XR 180 L / XRE 180 / CTX 200 / XL 200		X
3	HONDA	XR 200 / XRE 300		X
4				
5				



Cód. 1011055 DERECHA

Cód. original: 494804

No	MARCA	APLICACIONES	IZO	DER
1	PIAGGIO	PX 150		X
2	PIAGGIO	PX 150 VESPA		X
3				
4				
5				



Cód. 1011056 DERECHA

Cód. original: 57421-13001

No	MARCA	APLICACIONES	IZO	DER
1	AKT	RTX 150 UNISHOCK		X
2	SIGMA	SG 100 5A / SG 150 7 / SG 150 8		X
3	SUZUKI	EN 125 / GN 125 / GN 125 E / GN 125 H		X
4	SUZUKI	GN 125 NOVA / GS 125 / DR 650		X
5				

MANIGUETAS



JAPAN
Frenos de Alto Desempeño



Cód. 1011057

IZQUIERDA

Cód. original: 57620-20A02

No	MARCA	APLICACIONES	IZO	DER
1	SU_UKI	DR 650	X	
2	SUZUKI	FREEWIND XF 650	X	
3				
4				
5				



Cód. 1011058

DERECHA

Cód. original: 494804

No	MARCA	APLICACIONES	IZO	DER
1	PIAGGIO	PX 150		X
2	PIAGGIO	PX 150 VESPA		X
3				
4				
5				



Cód. 1011059

IZQUIERDA

Cód. original: 4VP-H3912-10

No	MARCA	APLICACIONES	IZO	DER
1	YAMAHA	BWS 100	X	
2	YAMAHA	BWS 125	X	
3	YAMAHA	BWS 125 X	X	
4				
5				



Cód. 1011061

IZQUIERDA

Cód. original: 3YF-83912-01

No	MARCA	APLICACIONES	IZO	DER
1	YAMAHA	LIBERO 110	X	
2	YAMAHA	LIBERO 125	X	
3	YAMAHA	YBR 125 DX	X	
4	YAMAHA	YBR 125 E	X	
5	YAMAHA	XT 600 / XT 600 E	X	



Cód. 1011062

DERECHA

Cód. original: 3YR-83922-00

No	MARCA	APLICACIONES	IZO	DER
1	YAMAHA	T 110 ED CRYPTON		X
2	YAMAHA	XT 600		X
3	YAMAHA	XT 600 E		X
4				
5				



Cód. 1011063

DERECHA

Cód. original: 4VP-H3922-00

No	MARCA	APLICACIONES	IZO	DER
1	YAMAHA	BWS 100		X
2				
3				
4				
5				



Cód. 1011064

IZQUIERDA

Cód. original: 57501-23410-00

No	MARCA	APLICACIONES	IZO	DER
1	SUZUKI	AX 100	X	
2				
3				
4				
5				



Cód. 1011065

DERECHA

Cód. original: 57301-20715-00

No	MARCA	APLICACIONES	IZO	DER
1	SUZUKI	AX 100		X
2				
3				
4				
5				



Cód. 1011066

IZQUIERDA

Cód. original: 53178-369-700

No	MARCA	APLICACIONES	IZO	DER
1	HONDA	CG 125	X	
2	HONDA	CB 250 NIGHT HAWK	X	
3	HONDA	CM 200	X	
4	HONDA	CX 500	X	
5	HONDA	XL 500	X	



Cód. 1011067

DERECHA

Cód. original: 53175-369-700

No	MARCA	APLICACIONES	IZO	DER
1	HONDA	CG 125		X
2				
3				
4				
5				



Cód. 1011070

DERECHA

Cód. original: DD-1911-42

No	MARCA	APLICACIONES	IZO	DER
1	BAJAJ	BOXER CARGO CT 100 / BOXER CT 100		X
2	BAJAJ	BOXER CT 100 ES		X
3	BAJAJ	BOXER CT 100 KS		X
4	BAJAJ	DISCOVER 100 / DISCOVER 100 M	X	
5	BAJAJ	PLATINO 100 / DISCOVER 110	X	
6	BAJAJ	DISCOVER 125 DTSI / PLATINO 125 5 SPEED	X	
7	BAJAJ	PLATINO 125 DTSI / BOXER BM 150	X	



Cód. 1011071

IZQUIERDA

Cód. original: DF-1910-12

No	MARCA	APLICACIONES	IZO	DER
1	BAJAJ	BOXER CARGO CT 100	X	
2	BAJAJ	BOXER CT 100	X	
3	BAJAJ	DISCOVER 100	X	
4	BAJAJ	PLATINO 100	X	
5	SUZUKI	HAYATE 110 / GIXXER 150	X	

MANIGUETAS



JAPAN
Frenos de Alto Desempeño



Cód. 1011072 DERECHA

Cód. original: 53170-KRF-S00

No	MARCA	APLICACIONES	IZO	DER
1	HONDA	CGL 125		X
2				
3				
4				
5				



Cód. 1011073 IZQUIERDA

Cód. original: 53180-KRF-S00

No	MARCA	APLICACIONES	IZO	DER
1	HERO	KARIZMA 250	X	
2	HONDA	CGL 125	X	
3	HONDA	E STORM 125	X	
4	HONDA	CBF 150	X	
5	HONDA	CBZ 160 / CB 190 R	X	



Cód. 1011074 DERECHA

Cód. original: 53175-GCE-900

No	MARCA	APLICACIONES	IZO	DER
1	HONDA	C 100 BIZ		X
2	HONDA	C 100 BIZ ES		X
3	HONDA	C 100 WAVE I		X
4				
5				



Cód. 1011075 IZQUIERDA

Cód. original: 271520088-0001

No	MARCA	APLICACIONES	IZO	DER
1	AKT	AK 100 S / AK 110 SII	X	
2	AKT	AK 125 EVO	X	
3	AKT	AK 125 NKD	X	
4	AKT	AK 125 NKDR	X	
5	AKT	AK 125 SL	X	



Cód. 1011076 DERECHA

Cód. original: 271720101-0001

No	MARCA	APLICACIONES	IZO	DER
1	AKT	AK 100 S		X
2	AKT	AK 125 SL		X
3				
4				
5				



Cód. 1011077 DERECHA

Cód. original: 271720163-0001

No	MARCA	APLICACIONES	IZO	DER
1	AKT	AK 110 SII		X
2				
3				
4				
5				



Cód. 1011078 DERECHA

Cód. original: 271710075-0001

No	MARCA	APLICACIONES	IZO	DER
1	AKT	AK 125 NKD PRIMER MODELO		X
2	NIPONIA	NIPONIA 125		X
3	SIGMA	SG 125		X
4				
5				



Cód. 1011079 DERECHA

Cód. original: 4AN-H3922-00

No	MARCA	APLICACIONES	IZO	DER
1	YAMAHA	DT 200 LC		X
2	YAMAHA	DT 200 R		X
3	YAMAHA	DT 200 WR		X
4				
5				



Cód. 1011080 IZQUIERDA

Cód. original: 4AN-H3912-00

No	MARCA	APLICACIONES	IZO	DER
1	YAMAHA	DT 200 LC	X	
2	YAMAHA	DT 200 R	X	
3	YAMAHA	DT 200 WR	X	
4				
5				



Cód. 1011081 IZQUIERDA

Cód. original: 271520088-0001

No	MARCA	APLICACIONES	IZO	DER
1	AKT	AK 100 S	X	
2	AKT	AK 125 SL	X	
3				
4				
5				



Cód. 1011082 DERECHA

Cód. original: 271720101-0001

No	MARCA	APLICACIONES	IZO	DER
1	AKT	AK 100 S		X
2	AKT	AK 125 EVO		X
3	AKT	AK 125 NKDR		X
4	AKT	AK 125 SL		X
5	SIGMA	SG 125 2A		X



Cód. 1011083 DERECHA

Cód. original: 271720163-0001

No	MARCA	APLICACIONES	IZO	DER
1	AKT	AK 100 S		X
2				
3				
4				
5				

MANIGUETAS



JAPAN
Frenos de Alto Desempeño



Cód. 1011084

IZQUIERDA

Cód. original: 57620-H45F1-0H0

No	MARCA	APLICACIONES	IZO	DER
1	SIGMA	SG 100 5A	X	
2	SUZUKI	GN 125	X	
3	SUZUKI	GN 125 E	X	
4	SUZUKI	GN 125 H	X	
5				



Cód. 1011085

DERECHA

Cód. original: 271710075-00011J

No	MARCA	APLICACIONES	IZO	DER
1	NIPONIA	NIPONIA 125		X
2	SIGMA	SG 125		X
3				
4				
5				



Cód. 1011086

IZQUIERDA

Cód. original: DJ-1910-55

No	MARCA	APLICACIONES	IZO	DER
1	BAJAJ	DISCOVER 125 DTSI / PLATINO 125 DTSI	X	
2	BAJAJ	XCD 125 / DISCOVER 135 / BOXER BM 150	X	
3	BAJAJ	DISCOVER 135 SPORT / PULSAR LS 135	X	
4	BAJAJ	DISCOVER 135 SUPREME / PULSAR 220 F	X	
5	BAJAJ	PULSAR 180 / PULSAR 180 II	X	
6	BAJAJ	PULSAR BLACK TEC 180 / PULSAR 220 S	X	
7	BAJAJ	PULSAR DTSI 180 / PULSAR UG 180	X	



Cód. 1011087

IZQUIERDA

Cód. original: 4LS-H3912-00

No	MARCA	APLICACIONES	IZO	DER
1	YAMAHA	YBR 125 ED / YBR 125 ESD / YBR 125 SS	X	
2	YAMAHA	FZ 16 2.0 / FZ 16 / FZ 16 ST FAZER	X	
3	YAMAHA	SZ 16 R / FZ 25	X	
4				
5				



Cód. 1011088

DERECHA

Cód. original: 57421-31CA1-000

No	MARCA	APLICACIONES	D	T
1	SUZUKI	FD 115		X
2	SUZUKI	VIVA X 115		X
3				
4				
5				



Cód. 1011089

IZQUIERDA

Cód. original: 57421-13001

No	MARCA	APLICACIONES	IZO	DER
1	SUZUKI	EN 125	X	
2	SUZUKI	GS 125	X	
3				
4				
5				



Cód. 1011090

DERECHA

Cód. original: 53175-KRF-H60

No	MARCA	APLICACIONES	IZO	DER
1	AKT	CR4 125 SE UNISHOCK		X
2	AUTECO V.	ADVANCE R 125		X
3	HONDA	NX 190		X
4	TVS	STRYKER 125		X
5	HONDA	CB 190R		X



Cód. 1011091

DERECHA

Cód. original: 5YY-H3922-00

No	MARCA	APLICACIONES	IZO	DER
1	YAMAHA	YBR 125 DX		X
2	YAMAHA	YBR 125 SS		X
3	YAMAHA	FZ 16		X
4	YAMAHA	FZ 16 ST FAZER		X
5				



Cód. 1011092

DERECHA

Cód. original: 4LS-H3922-00

No	MARCA	APLICACIONES	IZO	DER
1	YAMAHA	LIBERO 110		X
2	YAMAHA	YBR 125 E		X
3				
4				
5				



Cód. 1011093

DERECHA

Cód. original: DJ-1910-57

No	MARCA	APLICACIONES	IZO	DER
1	BAJAJ	PULSAR 180 / PULSAR 180 II		X
2	BAJAJ	PULSAR BLACK TEC 180		X
3	BAJAJ	PULSAR DTSI 180 / PULSAR UG 180		X
4	BAJAJ	PULSAR 220 F / PULSAR 220 S		X
5	BAJAJ			X



Cód. 1011098

DERECHA

Cód. original: N9322020

No	MARCA	APLICACIONES	IZO	DER
1	TVS	APACHE RTR 160		X
2	TVS	APACHE RTR 180		X
3	TVS	APACHE RTR 200 4V		X
4				
5				



Cód. 10110101

IZQUIERDA

Cód. original: 53178-KWF-9000

No	MARCA	APLICACIONES	IZO	DER
1	HONDA	CB 110 / NX 190		X
2	HONDA	CB 110 DLX / X-BLADE 160		X
3	HONDA	CBF 125		X
4	HONDA	CB 160 F STD		X
5				

MANIGUETAS



JAPAN
Frenos de Alto Desempeño



Cód. 10110102 DERECHA

Cód. original: 57175-KTE-910

No	MARCA	APLICACIONES	IZO	DER
1	HONDA	CB 110		X
2				
3				
4				
5				



Cód. 10110103 DERECHA

Cód. original: 53175-KVR-C00

No	MARCA	APLICACIONES	IZO	DER
1	HONDA	C 100 WAVE II		X
2				
3				
4				
5				



Cód. 10110104 IZQUIERDA

Cód. original: 53178-KRH-900

No	MARCA	APLICACIONES	IZO	DER
1	HONDA	XR 125 BRIO	X	
2	HONDA	XR 125 L	X	
3	HONDA	XR 125 L II	X	
4	HONDA	XR 150 L	X	
5	HONDA	XR 190 L	X	
6	HONDA	XRE 190	X	



Cód. 10110106 DERECHA

Cód. original: DJ191059

No	MARCA	APLICACIONES	IZO	DER
1	BAJAJ	DISCOVER 125 / DISCOVER 125 +		X
2	BAJAJ	DISCOVER 125 SPORT / DISCOVER 125 ST		X
3	BAJAJ	DISCOVER 125 UG / PULSAR LS 135		X
4	BAJAJ	DISCOVER 135 SUPREME		X
5	BAJAJ	DISCOVER 150 F / DISCOVER 150 ST		X



Cód. 10110107 IZQUIERDA

Cód. original: 2H0-83912-20

No	MARCA	APLICACIONES	IZO	DER
1	YAMAHA	DT 100	X	
2	YAMAHA	DT 125	X	
3	YAMAHA	DTK 125	X	
4	YAMAHA	DT 175	X	
5	YAMAHA	DT 175 C	X	



Cód. 10110108 DERECHA

Cód. original: 2H0-83922-00

No	MARCA	APLICACIONES	IZO	DER
1	YAMAHA	DT 100		X
2	YAMAHA	DT 125		X
3	YAMAHA	DTK 125		X
4	YAMAHA	DT 175		X
5	YAMAHA	DT 175 C		X



Cód. 10110117 DERECHA

Cód. original: 58P-H3922-00

No	MARCA	APLICACIONES	IZO	DER
1	YAMAHA	BWS 125		X
2	YAMAHA	BWS 125 X		X
3				
4				
5				



Cód. 10110118 IZQUIERDA

Cód. original: 57620-20A02

No	MARCA	APLICACIONES	IZO	DER
1	SUZUKI	V STROM 650 CLASSIC	X	
2				
3				
4				
5				



Cód. 10110120 DERECHA

Cód. original: 53175-LDC8-E10

No	MARCA	APLICACIONES	IZO	DER
1	KYMCO	AGILITY DIGITAL 125		X
2	KYMCO	AGILITY EXTREME 125		X
3	KYMCO	AGILITY FLY 125		X
4	KYMCO	AGILITY GO 125		X
5	KYMCO	AGILITY ROCKET 125		X



Cód. 10110121 IZQUIERDA

Cód. original: 53175-LDC8-E10

No	MARCA	APLICACIONES	IZO	DER
1	KYMCO	AGILITY DIGITAL 125		X
2	KYMCO	AGILITY EXTREME 125		X
3	KYMCO	AGILITY FLY 125		X
4	KYMCO	AGILITY GO 125		X
5	KYMCO	AGILITY ROCKET 125		X



Cód. 10110122 IZQUIERDA

Cód. original: 53178-KNBN-901-NE

No	MARCA	APLICACIONES	IZO	DER
1	KYMCO	AGILITY 150	X	
2	KYMCO	AGILITY CITY 150	X	
3				
4				
5				



Cód. 10110123 DERECHA

Cód. original: 53178-KNBN-901-NE

No	MARCA	APLICACIONES	IZO	DER
1	KYMCO	AGILITY 150		X
2	KYMCO	AGILITY CITY 150		X
3				
4				
5				

MANIGUETAS



JAPAN
Frenos de Alto Desempeño



Cód. 10110124 IZQUIERDA

Cód. original: DJ191083

No	MARCA	APLICACIONES	IZO	DER
1	BAJAJ	DISCOVER 100 M / DISCOVER 110	X	
2	BAJAJ	PULSAR NS PRO 200	X	
3	BAJAJ	PULSAR NS PULSARMANIA 200	X	
4	BAJAJ	DISCOVER 125 + / DISCOVER 125 SPORT	X	
5	BAJAJ	DISCOVER 125 ST / PULSAR NS 125	X	
6	BAJAJ	PULSAR NS 160 / PULSAR NS 200	X	
7				
8				
9				



Cód. 10110125 DERECHA

Cód. original: 1SB-H3922-00

No	MARCA	APLICACIONES	IZO	DER
1	YAMAHA	XTZ 125 E		X
2				
3				
4				
5				



Cód. 10110127 DERECHA

Cód. original: 5VK-83922-00

No	MARCA	APLICACIONES	IZO	DER
1	YAMAHA	XT 660 R		X
2				
3				
4				
5				



Cód. 10110129 IZQUIERDA

Cód. original: 57621053C0000

No	MARCA	APLICACIONES	IZO	DER
1	HAOJUE	HJ 150	X	
2	SUZUKI	GN 125 F EURO 3	X	
3	SUZUKI	GN 125 NOVA	X	
4				
5				



- Bandas de freno *Premium*
- Pastillas **JAPAN** *Premium Organics*
- Pastillas **JAPAN** *Premium Semimetallics*
- Pastillas **JAPAN** *Racing*
- Pastillas **JAPAN** *COMPETITION PRO*
- Pastillas **JAPAN** *Bike*
- Maniguetas
- Bases de Espejo
- Conjunto Base + Manigueta
- Discos de Freno
- Reposapiés
- Ejes de Rueda
- Ejes de Cambio
- Varillas de Freno
- Cuñas
- Pedales de Encendido
- Pedales de Cambio
- Pedales de Freno
- Tornillos
- Resortes de Banda
- Otros Productos
- Rines **Murelli**

Industrias Japan S.A



INDUSTRIAS JAPAN S.A.
Fabricantes de partes para motocicletas

Live safely



BASES DE ESPEJO

ALUMINIO DE EXCELENTE CALIDAD

1

Fabricadas en aleación de aluminio bajo controles estrictos de composición química, garantizando la resistencia mecánica requerida para este tipo de piezas.

2

Configuración y medidas controladas y aseguradas para su correcto ensamble en la motocicleta.

3

Dependiendo del modelo y referencias, se ofrecen con terminado en aluminio brillante o acabado en pintura negra electrostática.

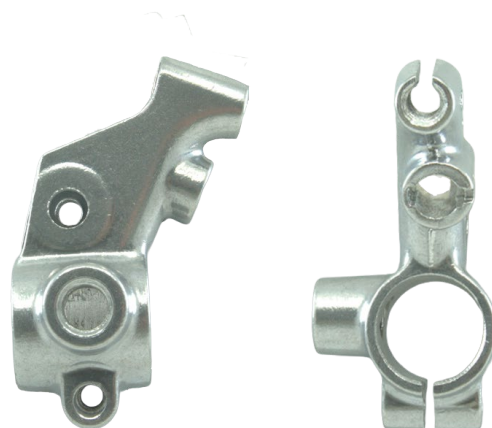

Para el desarrollo de las bases de espejo, así como de otros productos en Aluminio, **INDUSTRIAS JAPAN S.A** cuenta con sistemas CAD/CAM/CAE para diseño y fabricación de los moldes, así como la simulación para el proceso de inyección a presión. (DIE CASTING TECHNOLOGY).

El mecanizado de estos productos se realiza en máquinas automáticas de alta productividad y estabilidad.

Para más información sobre referencias y aplicaciones, consulte nuestra página web www.industriasjapan.com.

BASE MANIGUETA



JAPAN
Frenos de Alto Desempeño



ROSCA ESPEJO:
M10 x 1.25

Cód. **101021**

DERECHA



Cód. **101022**

IZQUIERDA



ROSCA ESPEJO:
M8 x 1.25

Cód. **101023**

IZQUIERDA

Cód. original: 361-82921-31

No	MARCA	APLICACIONES	IZO	DER
1	YAMAHA	DT 100 / DT 125 / DTK 125 / LIBERO 110		X
2	YAMAHA	RX 100 / RX 100 INDU / RX 100 JAPON		X
3	YAMAHA	YBR 125 E / DT 175 / DT 175 C		X
4				
5				

Cód. original: 498-82911-00

No	MARCA	APLICACIONES	IZO	DER
1	YAMAHA	DT 100 / DT 125 / DTK 125 / LIBERO 110	X	
2	YAMAHA	RX 100 / RX 100 INDU / RX 100 JAPON	X	
3	YAMAHA	DTK 125 / DT 175 / DT 175 C	X	
4				
5				

Cód. original: 57500-48500

No	MARCA	APLICACIONES	IZO	DER
1	SUZUKI	TS 100	X	
2	SUZUKI	TS 125 ER / TS 185 ER	X	
3	SUZUKI	TS 125 X	X	
4	SUZUKI	TS 125 Z	X	
5				



ROSCA ESPEJO:
M10 x 1.25

Cód. **101024**

IZQUIERDA



Cód. **101025**

IZQUIERDA



ROSCA ESPEJO:
M8 x 1.25

Cód. **101026**

DERECHA

Cód. original: 57500-48500

No	MARCA	APLICACIONES	IZO	DER
1	SUZUKI	TS 100 / AX 115	X	
2	SUZUKI	TS 125 CR / TS 125 ER	X	
3	SUZUKI	TS 125 X / TS 125 Z / TS 185 ER	X	
4	SUZUKI		X	
5				

Cód. original: 53172-310-010

No	MARCA	APLICACIONES	IZO	DER
1	HONDA	XL 100	X	
2	HONDA	XL 185	X	
3				
4				
5				

Cód. original: 57300-48500

No	MARCA	APLICACIONES	IZO	DER
1	SUZUKI	AX 100 / TS 100		X
2	SUZUKI	TS 125 CR / TS 125 ER		X
3	SUZUKI	TS 125 X / TS 185 ER		X
4	SUZUKI			X
5				

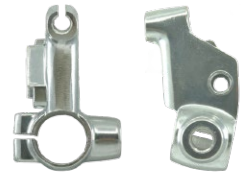

ROSCA ESPEJO:
M10 x 1.25

Cód. **101027**

DERECHA



ROSCA ESPEJO
IZQUIERDA:
M10 x 1.25

Cód. **101028**

DERECHA



ROSCA ESPEJO:
M8 x 1.25

Cód. **101029**

IZQUIERDA

Cód. original: 57500-48500

No	MARCA	APLICACIONES	IZO	DER
1	SUZUKI	TS 100 / AX 115		X
2	SUZUKI	TS 125 CR / TS 125 ER		X
3	SUZUKI	TS 125 X / TS 185 ER		X
4	SUZUKI			X
5				

Cód. original: 361-82921-31

No	MARCA	APLICACIONES	IZO	DER
1	YAMAHA	DT 100		X
2	YAMAHA	RX 100 / RX 100 INDU / RX 100 JAPON		X
3	YAMAHA	DT 125		X
4				
5				

Cód. original: 57500-48500

No	MARCA	APLICACIONES	IZO	DER
1	SUZUKI	TS 100 / AX 115	X	
2	SUZUKI	TS 125 CR / TS 125 ER	X	
3	SUZUKI	TS 125 X / TS 125 Z / TS 185 ER	X	
4	SUZUKI		X	
5				



ROSCA ESPEJO:
M10 x 1.25

Cód. **1010210**

IZQUIERDA



ROSCA ESPEJO:
M8 x 1.25

Cód. **1010211**

DERECHA



ROSCA ESPEJO:
M10 x 1.25

Cód. **1010212**

DERECHA

Cód. original: 57500-48500

No	MARCA	APLICACIONES	IZO	DER
1	SUZUKI	TS 100 / AX 115	X	
2	SUZUKI	TS 125 CR / TS 125 ER	X	
3	SUZUKI	TS 125 X / TS 125 Z / TS 185 ER	X	
4				
5				

Cód. original: 57300-48500

No	MARCA	APLICACIONES	IZO	DER
1	SUZUKI	TS 100 / AX 115		X
2	SUZUKI	TS 125 CR / TS 125 ER		X
3	SUZUKI	TS 125 X / TS 125 Z / TS 185 ER		X
4				
5				

Cód. original: 57300-48500

No	MARCA	APLICACIONES	IZO	DER
1	SUZUKI	TS 100 / AX 115		X
2	SUZUKI	TS 125 CR / TS 125 ER		X
3	SUZUKI	TS 125 X / TS 125 Z / TS 185 ER		X
4				
5				

BASE MANIGUETA



JAPAN
Frenos de Alto Desempeño



Cód. **1010214**

DERECHA



Cód. **1010215**

IZQUIERDA



Cód. **1010216**

DERECHA

ROSCA ESPEJO
IZQUIERDA:
M10 x 1.25

Cód. original: 53171-KB7-000

No	MARCA	APLICACIONES	IZO	DER
1	HONDA	XLR 125		X
2	HONDA	XLR 125 BRASIL		X
3	HONDA	XLR 125 TT		X
4				
5				

Cód. original: 53172-310-010

No	MARCA	APLICACIONES	IZO	DER
1	HONDA	XLR 125	X	
2	HONDA	XLR 125 BRASIL	X	
3	HONDA	XLR 125 TT	X	
4				
5				

Cód. original: 33G-82913-01

No	MARCA	APLICACIONES	IZO	DER
1	YAMAHA	DT 100		X
2	YAMAHA	DT 125		X
3	YAMAHA	DTK 125		X
4	YAMAHA	DT 175 / DT 175 C		X
5				



ROSCA ESPEJO
DERECHA:
M10 x 1.25

Cód. **1010217**

DERECHA



ROSCA ESPEJO
DERECHA:
M10 x 1.25

Cód. **1010218**

IZQUIERDA



ROSCA ESPEJO:
M10 x 1.25

Cód. **1010219**

DERECHA

Cód. original: 33G-82913-01

No	MARCA	APLICACIONES	IZO	DER
1	YAMAHA	DT 100		X
2	YAMAHA	DT 125		X
3	YAMAHA	DTK 125		X
4	YAMAHA	DT 175		X
5	YAMAHA	DT 175 C		X

Cód. original: 33G-82913-01

No	MARCA	APLICACIONES	IZO	DER
1	YAMAHA	DT 100 / DT 125 D / DT 125 DS / DTK 125	X	X
2	YAMAHA	LIBERO 125 / DT 175 / DT 175 C / DT 175 D	X	
3	YAMAHA	DT 175 E / DT 175 F / DTK 175	X	
4	YAMAHA	DT 200 R / DT 200 WR	X	
5	YAMAHA	XTZ 150 CROSSER / XT 660 R	X	

Cód. original: 53171-KGA-900

No	MARCA	APLICACIONES	IZO	DER
1	HONDA	CG 125 TITAN KS		X
2				
3				
4				
5				



ROSCA ESPEJO:
M10 x 1.25

Cód. **1010220**

IZQUIERDA



ROSCA ESPEJO:
M10 x 1.25

Cód. **1010222**

IZQUIERDA



ROSCA ESPEJO:
M10 x 1.25

Cód. **1010225**

IZQUIERDA

Cód. original: 53172-KCH-900

No	MARCA	APLICACIONES	IZO	DER
1	HONDA	CG 125 TITAN KS	X	
2				
3				
4				
5				

Cód. original: 3KA-H2911-00

No	MARCA	APLICACIONES	IZO	DER
1	YAMAHA	RX 115 S	X	
2				
3				
4				
5				

Cód. original: 52178-KCH-900

No	MARCA	APLICACIONES	IZO	DER
1	HONDA	CG 125 TITAN	X	
2	HONDA	CG 125 TITAN KS	X	
3				
4				
5				



Cód. **1010228**

DERECHA



Cód. **1010234**

DERECHA



Cód. **1010235**

DERECHA

Cód. original: -

No	MARCA	APLICACIONES	IZO	DER
1	YAMAHA	DT 100		X
2	YAMAHA	RX 100 / RX 100 INDU / RX 100 JAPON		X
3	YAMAHA	DT 125		X
4				
5				

Cód. original: 53172-198-900

No	MARCA	APLICACIONES	IZO	DER
1	HONDA	CD 100		X
2	HONDA	ECO 100		X
3				
4				
5				

Cód. original: 53171-GCE-900

No	MARCA	APLICACIONES	IZO	DER
1	HONDA	C 100 BIZ ES		X
2				
3				
4				
5				

BASE MANIGUETA



JAPAN
Frenos de Alto Desempeño



SIN ROSCA PARA
GRADUACIÓN DE GUAYA

Cód. **1010236**

IZQUIERDA



SIN ROSCA PARA
GRADUACIÓN DE GUAYA

Cód. **1010237**

DERECHA



Cód. **1010251**

DERECHA

Cód. original: 271410051-0001

No	MARCA	APLICACIONES	IZQ	DER
1	AKT	AK 125 SL	X	
2				
3				
4				
5				

Cód. original: -

No	MARCA	APLICACIONES	IZQ	DER
1	NIPPONIA	NIPPONIA 100		X
2	SIGMA	SG 100		X
3				
4				
5				

Cód. original: 53171-312-003

No	MARCA	APLICACIONES	IZQ	DER
1	HONDA	XL 100		X
2	HONDA	XL 185		X
3				
4				
5				



SIN ROSCA PARA
GRADUACIÓN DE GUAYA

Cód. **1010252**

DERECHA



SIN ROSCA PARA
GRADUACIÓN DE GUAYA

Cód. **1010253**

IZQUIERDA



CON ROSCA PARA
GRADUACIÓN DE GUAYA

Cód. **1010254**

IZQUIERDA

Cód. original: -

No	MARCA	APLICACIONES	IZQ	DER
1	NIPPONIA	NIPPONIA 100		X
2	SIGMA	SG 100		X
3				
4				
5				

Cód. original: 271410051-0001

No	MARCA	APLICACIONES	IZQ	DER
1	AKT	AK 125 SL	X	
2				
3				
4				
5				

Cód. original: -

No	MARCA	APLICACIONES	IZQ	DER
1	AKT	AK 125 SL	X	
2	HONDA	CG 125	X	
3				
4				
5				

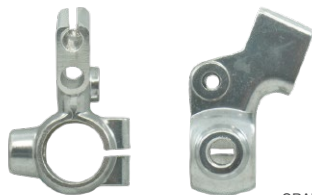

CON ROSCA PARA
GRADUACIÓN DE GUAYA

Cód. **1010255**

IZQUIERDA



CON ROSCA PARA
GRADUACIÓN DE GUAYA

Cód. **1010256**

DERECHA

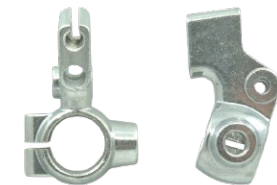

CON ROSCA PARA
GRADUACIÓN DE GUAYA

Cód. **1010257**

DERECHA

Cód. original: -

No	MARCA	APLICACIONES	IZQ	DER
1	HONDA	CG 125	X	
2				
3				
4				
5				

Cód. original: -

No	MARCA	APLICACIONES	IZQ	DER
1	AKT	AK 125 NKD		X
2	HONDA	CG 125		X
3				
4				
5				

Cód. original: -

No	MARCA	APLICACIONES	IZQ	DER
1	HONDA	CG 125		X
2				
3				
4				
5				



Cód. **1010263**

IZQUIERDA



Cód. **1010264**

DERECHA



Cód. **1010265**

IZQUIERDA

Cód. original: 53172-KTE-910

No	MARCA	APLICACIONES	IZQ	DER
1	HONDA	CB 110	X	
2	HONDA	CB 110 DLX	X	
3	HERO	SPLENDOR I SMART 110 FE	X	
4	HERO	SUPER SPLENDOR 125	X	
5				

Cód. original: 53171-KWS-900

No	MARCA	APLICACIONES	IZQ	DER
1	HONDA	CB 110		X
2				
3				
4				
5				

Cód. original: 53172-KRH-900

No	MARCA	APLICACIONES	IZQ	DER
1	HONDA	XR 125 BRIO	X	
2	HONDA	XR 125 L / XR 125 L II	X	
3	HONDA	XR 150 L	X	
4	HONDA	XR 190 L	X	
5	HONDA	XRE 190	X	

BASE MANIGUETA



JAPAN
Frenos de Alto Desempeño



SIN ROSCA PARA
GRADUACIÓN DE GUAYA

Cód. **1010236**

IZQUIERDA



SIN ROSCA PARA
GRADUACIÓN DE GUAYA

Cód. **1010237**

DERECHA

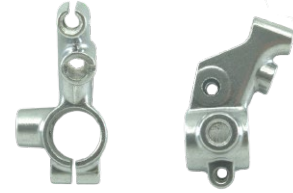

Cód. **1010229**

IZQUIERDA

Cód. original: 271410051-0001

No	MARCA	APLICACIONES	IZO	DER
1	AKT	AK 125 SL	X	
2				
3				
4				
5				

Cód. original: -

No	MARCA	APLICACIONES	IZO	DER
1	NIPPONIA	NIPPONIA 100		X
2	SIGMA	SG 100		X
3				
4				
5				

Cód. original: 498-82911-00

No	MARCA	APLICACIONES	IZO	DER
1	YAMAHA	RX 100	X	
2				
3			X	
4				
5				



- Bandas de freno *Premium*
- Pastillas **JAPAN** *Premium Organics*
- Pastillas **JAPAN** *Premium Semimetallics*
- Pastillas **JAPAN** *Racing*
- Pastillas **JAPAN** *COMPETITION PRO*
- Pastillas **JAPAN** *Bike*
- Maniguetas
- Bases de Espejo
- Conjunto Base + Manigueta
- Discos de Freno
- Reposapiés
- Ejes de Rueda
- Ejes de Cambio
- Varillas de Freno
- Cuñas
- Pedales de Encendido
- Pedales de Cambio
- Pedales de Freno
- Tornillos
- Resortes de Banda
- Otros Productos
- Rines **Murelli**

Industrias Japan S.A



INDUSTRIAS JAPAN S.A.
Fabricantes de partes para motocicletas

Live safely



CONJUNTOS BASE MANIGUETA

1

Fabricadas en aleación de aluminio bajo controles estrictos de composición química, garantizando la resistencia mecánica requerida para este tipo de piezas.

2

Configuración y medidas controladas y aseguradas para su correcto ensamble en la motocicleta.

3

Dependiendo del modelo y referencias, se ofrecen con terminado en aluminio brillante o acabado en pintura negra electrostática.



Para el desarrollo de los conjuntos base + manigueta, así como de otros productos en Aluminio, **INDUSTRIAS JAPAN S.A** cuenta con sistemas CAD/CAM/CAE para diseño y fabricación de los moldes, así como la simulación para el proceso de inyección a presión. (DIE CASTING TECHNOLOGY).

El mecanizado de estos productos se realiza en máquinas automáticas de alta productividad y estabilidad.

En el laboratorio de **INDUSTRIAS JAPAN S.A**, se realizan pruebas de resistencia mecánica a las maniguetas bajo estándares japoneses que garantizan la seguridad de estos elementos.

Para más información sobre referencias y aplicaciones, consulte nuestra página web www.industriasjapan.com.



Cód. 1012426

DERECHA

Cód. original: 2H0-83922-IJ

No	MARCA	APLICACIONES	IZO	DER
1	YAMAHA	DT 100		X
2	YAMAHA	DT 125		X
3	YAMAHA	DT 175		X
4	YAMAHA	RX 100		X
5				



ROSCA
IZQUIERDA

Cód. 1012427

DERECHA

Cód. original: 2H0-83922-IJ

No	MARCA	APLICACIONES	IZO	DER
1	YAMAHA	DT 100		X
2	YAMAHA	DT 125		X
3	YAMAHA	DT 175		X
4	YAMAHA	RX 100		X
5				



Cód. 1012428

IZQUIERDA

Cód. original: 2H0-83922-IJ

No	MARCA	APLICACIONES	IZO	DER
1	YAMAHA	DT 100	X	
2	YAMAHA	DT 125	X	
3	YAMAHA	DT 175	X	
4	YAMAHA	RX 100	X	
5				



Cód. 1012429

DERECHA

Cód. original: 53175-KTE-9IJ

No	MARCA	APLICACIONES	IZO	DER
1	HONDA	CB 110		X
2				
3				
4				
5				



Cód. 1012430

IZQUIERDA

Cód. original: 53178-KWF-9IJ

No	MARCA	APLICACIONES	IZO	DER
1	HONDA	CB 110	X	
2				
3				
4				
5				



- Bandas de freno *Premium*
- Pastillas **JAPAN** *Premium Organics*
- Pastillas **JAPAN** *Premium Semimetallics*
- Pastillas **JAPAN** *Racing*
- Pastillas **JAPAN** *COMPETITION PRO*
- Pastillas **JAPAN** *Bike*
- Maniguetas
- Bases de Espejo
- Conjunto Base + Manigueta
- Discos de Freno
- Reposapiés
- Ejes de Rueda
- Ejes de Cambio
- Varillas de Freno
- Cuñas
- Pedales de Encendido
- Pedales de Cambio
- Pedales de Freno
- Tornillos
- Resortes de Banda
- Otros Productos
- Rines **Murelli**

Industrias Japan S.A



INDUSTRIAS JAPAN S.A.
Fabricantes de partes para motocicletas

Live safely





DISCOS DE FRENO

ACERO INOXIDABLE
DE ALTA CALIDAD

1

DIMENSIONES PRECISAS

2

**ALTA RESISTENCIA A LA
ABRASIÓN Y OXIDACIÓN**



Los Discos de Freno son fabricados en acero inoxidable con un perfecto mecanizado de las superficies para un adecuado efecto de frenado.

Un balance perfecto entre precio y calidad optimizando la vida útil del disco gracias a los materiales que lo conforman.

DISCOS DE FRENO



JAPAN
Frenos de Alto Desempeño

DISCOS DE FRENO



JAPAN
Frenos de Alto Desempeño



Cód. **101911**

TRASERO

Cód. original: 69211-01D00-000

No	MARCA	APLICACIONES	D	T
1	SUZUKI	GS 500 E		X
2	SUZUKI	GS 500 E MODELO ANTIGUO		X
3	SUZUKI	GS 500 K1		X
4				



Cód. **101912**

DELANTERO

Cód. original: 4B4-F582T-01

No	MARCA	APLICACIONES	D	T
1	YAMAHA	XTZ 250		X
2				
3				
4				



Cód. **101913**

TRASERO

Cód. original: 5XT-2582W-00

No	MARCA	APLICACIONES	D	T
1	YAMAHA	XTZ 250		X
2				
3				
4				

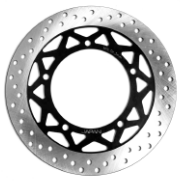

Cód. **101914**

DELANTERO

Cód. original: 3D9-F582U-10

No	MARCA	APLICACIONES	D	T
1	YAMAHA	LIBERO 125		X
2	YAMAHA	YBR 125 ESD		X
3				
4				



Cód. **101915**

DELANTERO

Cód. original: 5RM-F582T-00

No	MARCA	APLICACIONES	D	T
1	YAMAHA	XTZ 125 E		X
2	YAMAHA	XTZ 125 K		X
3	YAMAHA	DT 200 R		X
4	YAMAHA	DT 200 WR		X



Cód. **101916**

DELANTERO

Cód. original: 46P-F582T-00

No	MARCA	APLICACIONES	D	T
1	YAMAHA	BWS 125 X		X
2				
3				
4				



Cód. **101917**

DELANTERO

Cód. original: 59211-05350-000

No	MARCA	APLICACIONES	D	T
1	SUZUKI	GN 125		X
2	SUZUKI	GN 125 E		X
3	SUZUKI	GN 125 H		X
4	SUZUKI	GN 125 NOVA		X



Cód. **101918**

DELANTERO

Cód. original: 21C-F582U-00

No	MARCA	APLICACIONES	D	T
1	YAMAHA	FZ 16		X
2	YAMAHA	FZ 16 ST FAZER		X
3				
4				



Cód. **101919**

DELANTERO

Cód. original: 291420115-0001

No	MARCA	APLICACIONES	D	T
1	AKT	AK 125 SL		X
2				
3				
4				



Cód. **1019111**

DELANTERO

Cód. original: 59211-05500-504

No	MARCA	APLICACIONES	D	T
1	SUZUKI	EN 125		X
2	SUZUKI	GS 125		X
3				
4				



Cód. **1019112**

DELANTERO

Cód. original: 3HB-F582U-00

No	MARCA	APLICACIONES	D	T
1	YAMAHA	RX 115		X
2	YAMAHA	RX 115 S		X
3				
4				



Cód. **1019113**

DELANTERO

Cód. original: 45251-KVE-901

No	MARCA	APLICACIONES	D	T
1	HONDA	CBF 150		X
2	HONDA	INVICTA 150		X
3				
4				

DISCOS DE FRENO



JAPAN
Frenos de Alto Desempeño



Cód. 1019114 DELANTERO

Cód. original: 45121-LBA8-C100

No	MARCA	APLICACIONES	D	T
1	KYMCO	ACTIV 110	X	
2				
3				
4				



Cód. 1019115 DELANTERO

Cód. original: 7701023278836

No	MARCA	APLICACIONES	D	T
1	TVS	APACHE RTR 160	X	
2	TVS	APACHE RTR 180	X	
3	TVS	APACHE RTR 200	X	
4				

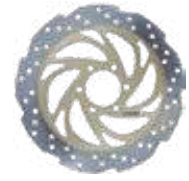

Cód. 1019116 DELANTERO

Cód. original: JL131005

No	MARCA	APLICACIONES	D	T
1	BAJAJ	PULSAR NS 200	X	
2	BAJAJ	PULSAR NS PRO 200	X	
3	BAJAJ	PULSAR NS PULSARMANIA 200	X	
4				



Cód. 1019117 DELANTERO

Cód. original: DK151027

No	MARCA	APLICACIONES	D	T
1	BAJAJ	PULSAR 180 NEON FI	X	
2	BAJAJ	PULSAR 220 SS	X	
3	BAJAJ	PULSAR UG 180	X	
4				



Cód. 1019118 DELANTERO

Cód. original: JZ131818

No	MARCA	APLICACIONES	D	T
1	BAJAJ	DISCOVER 125 ST	X	
2				
3				
4				



Cód. 1019119 DELANTERO

Cód. original: JD131810

No	MARCA	APLICACIONES	D	T
1	BAJAJ	PULSAR LS 135	X	
2	BAJAJ	PULSAR NS 125	X	
3				
4				

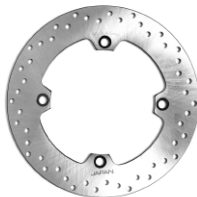

Cód. 1019120 TRASERO

Cód. original: 69211-06G00

No	MARCA	APLICACIONES	D	T
1	SUZUKI	V STROM 1050 DE		X
2	SUZUKI	V STROM 1050 XT		X
3	SUZUKI	V STROM 650 CLASSIC		X
4	SUZUKI	V STROM 800 (DL 800 DE)		X



Cód. 1019121 DELANTERO

Cód. original: 59210-44G11

No	MARCA	APLICACIONES	D	T
1	SUZUKI	GSX S 750 / GSR 750	X	
2	SUZUKI	GSR 600 / GSX 650 / GSX 1250	X	
3	SUZUKI	GSF BANDIT 650 / GSF BANDIT 1250	X	
4	SUZUKI	V STROM 650 CLASSIC	X	

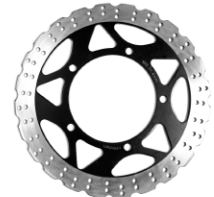

Cód. 1019122 DELANTERO

Cód. original: 41080-0578-11H

No	MARCA	APLICACIONES	D	T
1	KAWASAKI	NINJA 300 (2013-2017)	X	
2	KAWASAKI	Z 300 (2015-2017)	X	
3	KAWASAKI	Z 300 ABS	X	
4	KAWASAKI	VERSYS 300	X	



Cód. 1019123 TRASERO

Cód. original: 41080-0591-11H

No	MARCA	APLICACIONES	D	T
1	KAWASAKI	NINJA 300 (2013-2017)	X	
2	KAWASAKI	NINJA 250 (2002-2010)	X	
3	KAWASAKI	Z 300 ABS	X	
4	KAWASAKI	Z 300	X	

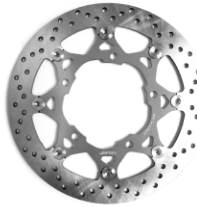

Cód. 1019124 DELANTERO

Cód. original: 59210-44G11

No	MARCA	APLICACIONES	D	T
1	SUZUKI	GSX S 750 / GSR 750	X	
2	SUZUKI	GSR 600 / GSX 650 / GSX 1250	X	
3	SUZUKI	GSF BANDIT 650 / GSF BANDIT 1250	X	
4	SUZUKI	V STROM 650 CLASSIC	X	



Cód. 1019125 DELANTERO

Cód. original: 5S9-F582U-00

No	MARCA	APLICACIONES	D	T
1	YAMAHA	BWS 125	X	
2				
3				
4				

DISCOS DE FRENO



JAPAN
Frenos de Alto Desempeño



Cód. **1019126**

TRASERO

Cód. original: N9111340

No	MARCA	APLICACIONES	D	T
1	TVS	APACHE 160 4V		X
2	TVS	APACHE RTR 180		X
3				
4				

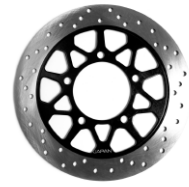

Cód. **1019128**

DELANTERO

Cód. original: 59211-34J60-000

No	MARCA	APLICACIONES	D	T
1	SUZUKI	GIXXER 150 - GIXXER 150 FI		X
2	SUZUKI	GIXXER 150 SF - GIXXER SF 150 ABS		X
3	SUZUKI	GIXXER SF 150 FI		X
4	SUZUKI	INTRUDER 150 - NEW GIXXER 150 ABS		X



Cód. **1019129**

DELANTERO

Cód. original: B0L-F582T-00

No	MARCA	APLICACIONES	D	T
1	YAMAHA	XTZ 150 CROSSER		X
2				
3				
4				



Cód. **1019131**

DELANTERO

Cód. original: 7701023587211

No	MARCA	APLICACIONES	D	T
1	AKT	TT 180 X - TT X 200		X
2				
3				
4				



Cód. **1019132**

DELANTERO

Cód. original: 59211-09G00-000

No	MARCA	APLICACIONES	D	T
1	SUZUKI	BEST 125		X
2				
3				
4				



Cód. **1019133**

DELANTERO

Cód. original: 7701023166676

No	MARCA	APLICACIONES	D	T
1	AKT	FLEX 125		X
2	AKT	FLEX EVOLUTION		X
3	AKT	FLEX LED 125		X
4				



Cód. **1019134**

DELANTERO

Cód. original: 7701023826808

No	MARCA	APLICACIONES	D	T
1	AKT	SPECIAL X 110		X
2				
3				
4				



Cód. **1019135**

DELANTERO

Cód. original: 41080-0578-11H

No	MARCA	APLICACIONES	D	T
1	SUZUKI	VIVA R 115		X
2	SUZUKI	VIVA R COOL EURO 3		X
3				
4				



Cód. **1019136**

DELANTERO

Cód. original: 7701023261777

No	MARCA	APLICACIONES	D	T
1	AKT	AK 125 NKDR		X
2	AKT	NKD 125 CBS		X
3	AKT	NKD EX 75		X
4	AKT	NKD MASTECH		X



Cód. **1019137**

DELANTERO

Cód. original: 7701023386371

No	MARCA	APLICACIONES	D	T
1	AKT	AK 125 TT-R - AK 150 TT R		X
2	AKT	TT 180 R		X
3	AKT	TT 200 DS		X
4	AKT	TT R 125 NS - TT R 200		X



Cód. **1019138**

DELANTERO

Cód. original: 59211H2C000H504

No	MARCA	APLICACIONES	D	T
1	BAJAJ	PULSAR NS 125		X
2	GENESIS	KA 150		X
3	HAOJUE	KA 150 HAOJUE		X
4				

DISCOS DE FRENO



JAPAN
Frenos de Alto Desempeño



Cód. **1019139**

TRASERO

Cód. original: JL131218

No	MARCA	APLICACIONES	D	T
1	BAJAJ	NS 200 UG ABS 2025		X
2	BAJAJ	PULSAR NS 200 - NS PULSAR MANIA 200		X
3	BAJAJ	PULSAR NS 200 FI ABS		X
4	BAJAJ	PULSAR NS PRO 200		X



Cód. **1019140**

TRASERO

Cód. original: JF131861

No	MARCA	APLICACIONES	D	T
1	BAJAJ	DOMINAR 250		X
2	BAJAJ	DOMINAR UG 400		X



Cód. **1019141**

TRASERO

Cód. original: 2DP-F582W-00

No	MARCA	APLICACIONES	D	T
1	YAMAHA	N MAX 150		X
2	YAMAHA	NMAX CONNECTED		X



Cód. **1019142**

TRASERO

Cód. original: 69211-34J00-000

No	MARCA	APLICACIONES	D	T
1	SUZUKI	GIXXER 150 FI		X
2	SUZUKI	GIXXER 150 SF		X
3	SUZUKI	GIXXER SF 150 ABS		X
4	SUZUKI	GIXXER SF 150 FI		X



Cód. **1019143**

TRASERO

Cód. original: 7701023080316

No	MARCA	APLICACIONES	D	T
1	AKT	TT 180 R		X
2	AKT	TT 200 DS		X
3	AKT	TT R 200		X
4				



Cód. **1019144**

DELANTERO

Cód. original: JH131885

No	MARCA	APLICACIONES	D	T
1	BAJAJ	DISCOVER 125 UG CBS		X
2	BAJAJ	PLATINO 125 CBS 4 VEL.		X
3				
4				



Cód. **1019130**

DELANTERO

Cód. original: 3KJ-17611-00

No	MARCA	APLICACIONES	D	T
1	SUZUKI	DR 150		X
2				
3				
4				



Cód. **101501**

FRISADOR

Cód. original: 3KJ-17611-00

No	MARCA	APLICACIONES	D	T
1	YAMAHA	CY 50 JOG	-	-
2				
3				
4				



- Bandas de freno *Premium*
- Pastillas **JAPAN** *Premium Organics*
- Pastillas **JAPAN** *Premium Semimetallics*
- Pastillas **JAPAN** *Racing*
- Pastillas **JAPAN** *COMPETITION PRO*
- Pastillas **JAPAN** *Bike*
- Maniguetas
- Bases de Espejo
- Conjunto Base + Manigueta
- Discos de Freno
- Reposapiés
- Ejes de Rueda
- Ejes de Cambio
- Varillas de Freno
- Cuñas
- Pedales de Encendido
- Pedales de Cambio
- Pedales de Freno
- Tornillos
- Resortes de Banda
- Otros Productos
- Rines **Murelli**

Industrias Japan S.A



INDUSTRIAS JAPAN S.A.
Fabricantes de partes para motocicletas

Live safely





REPOSAPIES

Reposapiés en diferentes estilos, clásicos fabricados en láminas de acero con cubierta de caucho y deportivos fabricados con aluminio de alta calidad garantizando efectividad y resistencia.



EJES DE RUEDA

Con el diseño de su cabeza forjada por recalcado en caliente, que forma un cuerpo monolítico, rosca laminada en frío y cuerpo rectificado en CNC (control Numérico Computarizado). este producto asegura una buena resistencia, mecánica y emsamble.

Dependiendo la referencia se ofrecen con terminado en zincado blanco o amarillo y se entregan con las respectivas tuercas de seguridad.



EJES DE CAMBIO

Fabricado en acero de alta resistencia, con estría laminada en frío, mecanizados en maquinaria CNC donde se controla sus medidas con precisión para garantizar su ensamble y funcionamiento en la motocicletas.



REPOSAPIES



JAPAN

Frenos de Alto Desempeño



Cód. **101091**

TRASERO

Cód. original: 120-27430-02

No	MARCA	APLICACIONES
1	YAMAHA	V 80
2	YAMAHA	DT 125 / DTK 125
3	YAMAHA	DT 175 / DT 175 C / DT 175 E
4		



Cód. **101092**

TRASERO

Cód. original: 120-27431-02

No	MARCA	APLICACIONES
1	YAMAHA	RX 100
2	YAMAHA	RX 100 INDU
3	YAMAHA	RX 100 JAPON
4		



Cód. **101093**

TRASERO

Cód. original: 43600-03001

No	MARCA	APLICACIONES
1	SUZUKI	FR 80
2	SUZUKI	FR 100
3		
4		



Cód. **101094**

TRASERO

Cód. original: 92076-027

No	MARCA	APLICACIONES
1	KAWASAKI	KV 100
2		
3		
4		



Cód. **101095**

TRASERO

Cód. original: 50175-413-000

No	MARCA	APLICACIONES
1	HONDA	C 70
2	HONDA	C 90 / C 90 E
3	HONDA	XL 100
4	HONDA	XL 185



Cód. **101096**

TRASERO

Cód. original: 3TL-F7430-50

No	MARCA	APLICACIONES
1	YAMAHA	DT 125 D
2	YAMAHA	DT 125 DS
3	YAMAHA	DT 175 D
4	YAMAHA	DT 175 F / DTK 175



Cód. **101097**

TRASERO IZQUIERDO

Cód. original: -

No	MARCA	APLICACIONES
1	SUZUKI	A 80
2	SUZUKI	A 100
3		
4		



Cód. **101098**

TRASERO

Cód. original: -

No	MARCA	APLICACIONES
1	KAWASAKI	KV 100
2		
3		
4		



Rojo*

Cód. **1010910**

TRASERO LARGO

Cód. original: -

No	MARCA	APLICACIONES
1	UNIVERSAL	UNIVERSAL
2		
3		
4		



Rojo*

Cód. **1010911**

TRASERO CORTO

Cód. original: -

No	MARCA	APLICACIONES
1	UNIVERSAL	UNIVERSAL
2		
3		
4		



Cód. **1010912**

TRASERO LARGO

Cód. original: -

No	MARCA	APLICACIONES
1	UNIVERSAL	UNIVERSAL
2		
3		
4		



Cód. **1010913**

TRASERO CORTO

Cód. original: -

No	MARCA	APLICACIONES
1	UNIVERSAL	UNIVERSAL
2		
3		
4		



Cód. 1010914 TRASERO CORTO

Cód. original: -

No	MARCA	APLICACIONES
1	UNIVERSAL	UNIVERSAL
2		
3		
4		



Cód. 1010915 TRASERO LARGO

Cód. original: -

No	MARCA	APLICACIONES
1	UNIVERSAL	UNIVERSAL
2		
3		
4		



Cód. 1010961 TRASERO IZQUIERDO

Cód. original: 3TL-F7430-60

No	MARCA	APLICACIONES
1	YAMAHA	DT 125 D / DT 125 DS
2	YAMAHA	DT 175 D / DT 175 E
3	YAMAHA	DT 175 F / DTK 175
4		



Cód. 1010971 TRASERO

Cód. original: -

No	MARCA	APLICACIONES
1	SUZUKI	A 80
2	SUZUKI	A 100
3		
4		



Cód. 1010981 TRASERO

Cód. original: -

No	MARCA	APLICACIONES
1	KAWASAKI	KV 100
2		
3		
4		



Cód. 1010991 TRASERO

Cód. original: 120-27430-02

No	MARCA	APLICACIONES
1	YAMAHA	V 80
2	YAMAHA	DT 125 / DTK 125
3	YAMAHA	DT 175 / DT 175 C / DT 175 E
4		



Cód. 1010992 TRASERO

Cód. original: 120-27431-02

No	MARCA	APLICACIONES
1	YAMAHA	RX 100 / RX 100 INDU / RX 100 JAPON
2	YAMAHA	RX 115 S / XT 225
3		
4		



Cód. 1010993 TRASERO

Cód. original: 43600-03001

No	MARCA	APLICACIONES
1	SUZUKI	A 80
2	SUZUKI	A 100
3		
4		



Cód. 1010994 TRASERO

Cód. original: 92076-027

No	MARCA	APLICACIONES
1	KAWASAKI	KV 100
2		
3		
4		



Cód. 1010995 TRASERO

Cód. original: 50175-413-000

No	MARCA	APLICACIONES
1	HONDA	C 70
2	HONDA	C 90 / C 90 E
3	HONDA	XL 100 / XL 185
4		



- Bandas de freno *Premium*
- Pastillas **JAPAN** *Premium Organics*
- Pastillas **JAPAN** *Premium Semimetallics*
- Pastillas **JAPAN** *Racing*
- Pastillas **JAPAN** *COMPETITION PRO*
- Pastillas **JAPAN** *Bike*
- Maniguetas
- Discos de freno
- Bases de espejo
- Reposapiés
- Ejes de rueda
- Ejes de cambio
- Varillas de freno
- Cuñas
- Pedales de encendido
- Pedales de cambio
- Pedales de Freno
- Tornillos
- Resortes de banda
- Otros productos

Industrias Japan S.A



INDUSTRIAS JAPAN S.A.
Fabricantes de partes para motocicletas
Live safely





REPOSAPIES

Reposapiés en diferentes estilos, clásicos fabricados en láminas de acero con cubierta de caucho y deportivos fabricados con aluminio de alta calidad garantizando efectividad y resistencia.



EJES DE RUEDA

Con el diseño de su cabeza forjada por recalcado en caliente, que forma un cuerpo monolítico, rosca laminada en frío y cuerpo rectificado en CNC (control Numérico Computarizado). este producto asegura una buena resistencia, mecánica y emsamble.

Dependiendo la referencia se ofrecen con terminado en zincado blanco o amarillo y se entregan con las respectivas tuercas de seguridad.



EJES DE CAMBIO

Fabricado en acero de alta resistencia, con estría laminada en frío, mecanizados en maquinaria CNC donde se controla sus medidas con precisión para garantizar su ensamble y funcionamiento en la motocicletas.



Cód. 101121

TRASERO

Cód. original: 41068-1109

No	MARCA	APLICACIONES	D	T
1	KAWASAKI	G7 100		X
2	KAWASAKI	NEOMAX 100		X
3	SUZUKI	FR 100		X
4				
5				



Cód. 101122

DELANTERO

Cód. original: 54711-48700

No	MARCA	APLICACIONES	D	T
1	SUZUKI	TS 125 Z	X	
2				
3				
4				
5				



Cód. 101123

TRASERO

Cód. original: 64711-39201

No	MARCA	APLICACIONES	D	T
1	SUZUKI	AX 100		X
2	SUZUKI	AX 115		X
3				
4				
5				



Cód. 101124

DELANTERO

Cód. original: 353-25381-00

No	MARCA	APLICACIONES	D	T
1	YAMAHA	DT 100 K / RX 100	X	
2	YAMAHA	DT 125 D / DT 125 DS / DTK 125	X	
3	YAMAHA	DT 175 G / DT 175 D / DT 175 E / DT 175 F	X	
4	YAMAHA	DTK 175	X	
5				



Cód. 101125

TRASERO

Cód. original: 64711-05200

No	MARCA	APLICACIONES	D	T
1	SUZUKI	TS 125 Z	X	
2				
3				
4				
5				



Cód. 101126

TRASERO

Cód. original: 18G-25381-00

No	MARCA	APLICACIONES	D	T
1	YAMAHA	DT 125 D / DTK 125		X
2	YAMAHA	DT 175 C / DT 175 D		X
3	YAMAHA	DT 175 E / DT 175 F / DTK 175		X
4	YAMAHA	XT 225		X
5				



Cód. 101127

DELANTERO

Cód. original: 54711-03602

No	MARCA	APLICACIONES	D	T
1	SUZUKI	FR 80	X	
2	SUZUKI	AX 100	X	
3	SUZUKI	FR 100	X	
4	SUZUKI	AX 115	X	
5				



Cód. 101128

TRASERO

Cód. original: 5H5-25381-00

No	MARCA	APLICACIONES	D	T
1	YAMAHA	RX 100		X
2	YAMAHA	RX 100 JAPON		X
3	YAMAHA	RX 115		X
4				
5				



Cód. 101129

DELANTERO

Cód. original: 296-25181-02

No	MARCA	APLICACIONES	D	T
1	YAMAHA	V 80		X
2				
3				
4				
5				



Cód. 1011210

TRASERO

Cód. original: 401-25181-01

No	MARCA	APLICACIONES	D	T
1	SUZUKI	TS 185 ER	X	
2	YAMAHA	V 80		X
3	YAMAHA	YB 100		X
4				
5				



Cód. 1011212

TRASERO

Cód. original: 3AY-F5381-01

No	MARCA	APLICACIONES	D	T
1	HERO	XPULSE 200 T	X	
2	SUZUKI	VIVA R 115		X
3	YAMAHA	CRYPTON 110 EZ		X
4	YAMAHA	RX 115 S		X
5				



Cód. 1011213

DELANTERO

Cód. original: 44301-GBJ-000

No	MARCA	APLICACIONES	D	T
1	HONDA	C 70 / C 90 / C 90 E		X
2	KAWASAKI	AN 80 G2 JOY		X
3	KAWASAKI	NEOMAX 100		X
4	KAWASAKI	CHEER 112		X
5				



Cód. 1011216 TRASERO

Cód. original: 42301-198-900

No	MARCA	APLICACIONES	D	T
1	HONDA	CD 100	X	
2	HONDA	ECO 100	X	
3				
4				
5				



Cód. 1011218 DELANTERO

Cód. original: 3M5-2

No	MARCA	APLICACIONES	D	T
1	YAMAHA	RX 115	X	
2	YAMAHA	RX 115 S	X	
3	YAMAHA	RXZ 135	X	
4				
5				



Cód. 1011220 DELANTERO

Cód. original: 44301-198-900

No	MARCA	APLICACIONES	D	T
1	HONDA	CD 100	X	
2	HONDA	ECO 100	X	
3				
4				
5				



Cód. 1011221 TRASERO

Cód. original: 36L-FS381-00

No	MARCA	APLICACIONES	D	T
1	YAMAHA	RX 100 INDU	X	
2	YAMAHA	YZZ 110	X	
3				
4				
5				



Cód. 1011222 DELANTERO

Cód. original: 31-1510-36

No	MARCA	APLICACIONES	D	T
1	BAJAJ	BOXER CT 100 ES	X	
2	BAJAJ	BOXER CT 100 ES TITANIUM	X	
3	BAJAJ	BOXER CT 100 KS	X	
4	BAJAJ	PLATINO 110	X	
5				



Cód. 1011223 TRASERO

Cód. original: 64711-29301

No	MARCA	APLICACIONES	D	T
1	SUZUKI	TS 185 ER		X
2				
3				
4				
5				



Cód. 1011224 TRASERO

Cód. original: 42301-041-030

No	MARCA	APLICACIONES	D	T
1	HONDA	C 70	X	
2	HONDA	C 90	X	
3	HONDA	C 90 E	X	
4	HERO	SPLENDOR I SMART 110 FE	X	
5				



Cód. 1011225 DELANTERO

Cód. original: 2JG-25181-00

No	MARCA	APLICACIONES	D	T
1	SUZUKI	VIVA R 115	X	
2	YAMAHA	CRYPTON 110 EZ	X	
3	YAMAHA	T 110 CRYPTON	X	
4	YAMAHA	T 110 ED CRYPTON	X	
5				



Cód. 1011226 TRASERO

Cód. original: 31-1510-01

No	MARCA	APLICACIONES	D	T
1	BAJAJ	BOXER CARGO CT 100		X
2	BAJAJ	BOXER CT 100		X
3				
4				
5				



Cód. 1011228 DELANTERO

Cód. original: 44301-KGA-900

No	MARCA	APLICACIONES	D	T
1	HONDA	CG 125 ES	X	
2	HONDA	CG 125 TITAN KSE	X	
3	SUZUKI	AX 4	X	
4				
5				



Cód. 1011230 TRASERO

Cód. original: DJ-1510-32

No	MARCA	APLICACIONES	D	T
1	BAJAJ	PULSAR 180		X
2	BAJAJ	PULSAR 180 II		X
3	BAJAJ	PULSAR BLACK TEC 180		X
4	BAJAJ	PULSAR DTSI 180		X
5				



Cód. 1011231 DELANTERO

Cód. original: DJ-1510-41

No	MARCA	APLICACIONES	D	T
1	BAJAJ	PULSAR 180	X	
2	BAJAJ	PULSAR 180 II	X	
3	BAJAJ	PULSAR BLACK TEC 180	X	
4	BAJAJ	PULSAR DTSI 180	X	
5				



Cód. **1011232**

TRASERO

Cód. original: 42301-KRE-900

No	MARCA	APLICACIONES	D	T
1	HONDA	NXR 125 BROSS		X
2	HONDA	XLR 125		X
3	HONDA	XLR 125 BRASIL		X
4	HONDA	XLR 125 TT		X
5				



Cód. **1011234**

TRASERO

Cód. original: 42301-KRF-500

No	MARCA	APLICACIONES	D	T
1	HONDA	CGL 125		X
2	HONDA	E STORM 125		X
3				
4				
5				



Cód. **1011235**

DELANTERO

Cód. original: 44301-KRE-900

No	MARCA	APLICACIONES	D	T
1	HONDA	NXR 125 BROSS		X
2				
3				
4				
5				



Cód. **1011236**

DELANTERO

Cód. original: 44301-KRF-500

No	MARCA	APLICACIONES	D	T
1	HONDA	CGL 125		X
2	HONDA	E STORM 125		X
3				
4				
5				



Cód. **1011237**

TRASERO

Cód. original: PP-21901-000

No	MARCA	APLICACIONES	D	T
1	AKT	AK 125 NKDR		X
2	AKT	AK 125 SL		X
3				
4				
5				



Cód. **1011238**

DELANTERO

Cód. original: PM-11901-000

No	MARCA	APLICACIONES	D	T
1	AKT	AK 125 NKDR		X
2	AKT	AK 125 SL		X
3				
4				
5				



Cód. **1011248**

DELANTERO

Cód. original: 44301-KSP-900

No	MARCA	APLICACIONES	D	T
1	HONDA	C 100 WAVE I		X
2	HERO	THRILLER 150		X
3	AKT	CR4 125 SE UNISHOCK		X
4	AKT	AK 125 EVO II		X
5				



Cód. **1011250**

TRASERO

Cód. original: DK151009

No	MARCA	APLICACIONES	D	T
1	BAJAJ	PULSAR UG 180		X
2	BAJAJ	PULSAR 220 F		X
3	BAJAJ	PULSAR 220 S		X
4				
5				



Cód. **1011251**

TRASERO

Cód. original: DX151016

No	MARCA	APLICACIONES	D	T
1	BAJAJ	DISCOVER 100		X
2	BAJAJ	XCD 125		X
3				
4				
5				



Cód. **1011252**

TRASERO

Cód. original: JK131201

No	MARCA	APLICACIONES	D	T
1	BAJAJ	PLATINO 100		X
2				
3				
4				
5				



Cód. **1011253**

TRASERO

Cód. original: DU151029

No	MARCA	APLICACIONES	D	T
1	BAJAJ	BOXER CARGO CT 100		X
2	BAJAJ	BOXER CT 100		X
3	BAJAJ	BOXER S 100		X
4				
5				



Cód. **1011254**

TRASERO

Cód. original: 5VL-F5381-01

No	MARCA	APLICACIONES	D	T
1	YAMAHA	LIBERO 125		X
2	YAMAHA	XTZ 150 CROSSER		X
3				
4				
5				



Cód. **1011255**

TRASERO

Cód. original: PA131239

No	MARCA	APLICACIONES	D	T
1	BAJAJ	DISCOVER 100 M		X
2				
3				
4				
5				



Cód. **1011256**

DELANTERO

Cód. original: 44301-KWW-640

No	MARCA	APLICACIONES	D	T
1	AKT	EVO R3	X	
2	KYMCO	ACTIV 110		X
3				
4				
5				



Cód. **1011257**

TRASERO

Cód. original: 42301-KRS-830

No	MARCA	APLICACIONES	D	T
1	HONDA	C 100 WAVE I		X
2	HONDA	C 100 WAVE II		X
3				
4				
5				



Cód. **1011258**

DELANTERO

Cód. original: 54711-05300-000

No	MARCA	APLICACIONES	D	T
1	SUZUKI	GN 125	X	
2	SUZUKI	GN 125 E	X	
3	SUZUKI	GN 125 H	X	
4	SUZUKI	GN 125 NOVA	X	
5				



Cód. **1011259**

TRASERO

Cód. original: 64711H2A000H000

No	MARCA	APLICACIONES	D	T
1	SUZUKI	GN 125	X	
2	SUZUKI	GN 125 E	X	
3	SUZUKI	GN 125 H	X	
4	SUZUKI	GN 125 NOVA	X	
5				



Cód. **1011260**

TRASERO

Cód. original: 44301-KFW6-9010

No	MARCA	APLICACIONES	D	T
1	KYMCO	ACTIV 110		X
2	AKT	EVO R3	X	
3				
4				
5				



Cód. **1011261**

TRASERO

Cód. original: 21C-F5381-00

No	MARCA	APLICACIONES	D	T
1	YAMAHA	FZ 16 2.0		X
2	YAMAHA	FZ 16		X
3	YAMAHA	FZ 16 ST FAZER		X
4	YAMAHA	FZ 25		X
5				



Cód. **1011262**

DELANTERO

Cód. original: 21C-F5181-00

No	MARCA	APLICACIONES	D	T
1	YAMAHA	FZ 16 2.0	X	
2	YAMAHA	FZ 16	X	
3	YAMAHA	FZ 16 ST FAZER	X	
4	YAMAHA	FZ 25	X	
5				



Cód. **1011263**

DELANTERO

Cód. original: 44301-KPL-900

No	MARCA	APLICACIONES	D	T
1	HONDA	CB 110	X	
2	HONDA	CB 125 F	X	
3				
4				
5				



Cód. **1011264**

DELANTERO

Cód. original: 1SB-F5181-00

No	MARCA	APLICACIONES	D	T
1	YAMAHA	XTZ 125 E	X	
2	YAMAHA	XTZ 125 K	X	
3				
4				
5				



Cód. **1011265**

TRASERO

Cód. original: 1SB-F5381-00

No	MARCA	APLICACIONES	D	T
1	YAMAHA	XTZ 125 E		X
2	YAMAHA	XTZ 125 K		X
3				
4				
5				



Cód. **1011266**

TRASERO

Cód. original: 42301-KWS-900

No	MARCA	APLICACIONES	D	T
1	HONDA	CB 110		X
2	AUTECO V.	MRX 200 GRIS PIEDRA	X	
3				
4				
5				



Cód. 1011267 DELANTERO

Cód. original: DK-1510-08

No	MARCA	APLICACIONES	D	T
1	BAJAJ	PULSAR UG 150	X	
2				
3				
4				
5				



Cód. 1011268 DELANTERO

Cód. original: 4WX-F5181-00

No	MARCA	APLICACIONES	D	T
1	YAMAHA	BWS 100	X	
2	YAMAHA	N MAX 150	X	
3				
4				
5				



Cód. 1011269 DELANTERO

Cód. original: 36L-F5181-00

No	MARCA	APLICACIONES	D	T
1	YAMAHA	RX 100 INDU	X	
2	YAMAHA	LIBERO 110	X	
3	YAMAHA	YC Z 110	X	
4	YAMAHA	CRYPTON 115	X	
5				



Cód. 1011270 DELANTERO

Cód. original: 54711-34J00-000

No	MARCA	APLICACIONES	D	T
1	SUZUKI	AX 4		X
2	SUZUKI	AX4 EURO 3		X
3	SUZUKI	GIXXER 150	X	
4	SUZUKI	GIXXER 150 FI	X	
5				



Cód. 1011271 DELANTERO

Cód. original: N8111860

No	MARCA	APLICACIONES	D	T
1	TVS	APACHE RTR 200 4V	X	
2	TVS	APACHE 200 BS6 FI ABS	X	
3	HERO	X PULSE 200 T		X
4	YAMAHA	YZF R15	X	
5				



Cód. 1011272 TRASERO

Cód. original: 64711-34J00-000

No	MARCA	APLICACIONES	D	T
1	SUZUKI	GIXXER 150 FI		X
2	SUZUKI	GIXXER SF 150 FI		X
3	SUZUKI	INTRUDER 150		X
4	SUZUKI	NEW GIXXER 150 ABS		X
5				



Cód. 1011273 TRASERO

Cód. original: 42301-KRE-900

No	MARCA	APLICACIONES	D	T
1	HONDA	CB 125 F		X
2	HONDA	XR 125 L		X
3	HONDA	XR 150 L		X
4				
5				



Cód. 1011274 TRASERO

Cód. original: 54B-F5381-00

No	MARCA	APLICACIONES	D	T
1	YAMAHA	SZ 15 RR		X
2	YAMAHA	SZ 16 R		X
3				
4				
5				



Cód. 1011275 TRASERO

Cód. original: 7701023705080

No	MARCA	APLICACIONES	D	T
1	AKT	EVO R3		X
2	SUZUKI	GSX R 150		X
3				
4				
5				



Cód. 1011277 TRASERO

Cód. original: N/A

No	MARCA	APLICACIONES	D	T
1	BAJAJ	DOMINAR 250		X
2	BAJAJ	NS 200 UG ABS 2025		X
3	BAJAJ	NS 400		X
4	BAJAJ	PULSAR NS 200 FI ABS		X
5	BAJAJ	PULSAR RS 200		X



Cód. 1011278 TRASERO

Cód. original: N/A

No	MARCA	APLICACIONES	D	T
1	HERO	ECO DELUXE FE 100		X
2	HERO	ECO DELUXE i3S		X
3	HERO	PASSION PRO 100		X
4	HERO	SPLENDOR I SMART 110 FE		X
5				



Cód. 1011279 TRASERO

Cód. original: N/A

No	MARCA	APLICACIONES	D	T
1	HERO	ECO DELUXE FE 100		X
2	HERO	ECO DELUXE i3S - GLAMOUR 125		X
3	HERO	IGNITOR 125 SS - PASSION PRO 100		X
4	HERO	SPLENDOR I SMART 110 FE		X
5	HERO	SUPER SPLENDOR 125		X



- Bandas de freno *Premium*
- Pastillas **JAPAN** *Premium Organics*
- Pastillas **JAPAN** *Premium Semimetallics*
- Pastillas **JAPAN** *Racing*
- Pastillas **JAPAN** *COMPETITION PRO*
- Pastillas **JAPAN** *Bike*
- Maniguetas
- Bases de Espejo
- Conjunto Base + Manigueta
- Discos de Freno
- Reposapiés
- Ejes de Rueda
- Ejes de Cambio
- Varillas de Freno
- Cuñas
- Pedales de Encendido
- Pedales de Cambio
- Pedales de Freno
- Tornillos
- Resortes de Banda
- Otros Productos
- Rines **Murelli**

Industrias Japan S.A



INDUSTRIAS JAPAN S.A.
Fabricantes de partes para motocicletas

Live safely





REPOSAPIES

Reposapiés en diferentes estilos, clásicos fabricados en láminas de acero con cubierta de caucho y deportivos fabricados con aluminio de alta calidad garantizando efectividad y resistencia.



EJES DE RUEDA

Con el diseño de su cabeza forjada por recalcado en caliente, que forma un cuerpo monolítico, rosca laminada en frío y cuerpo rectificado en CNC (control Numérico Computarizado). este producto asegura una buena resistencia, mecánica y emsamble.

Dependiendo la referencia se ofrecen con terminado en zincado blanco o amarillo y se entregan con las respectivas tuercas de seguridad.



EJES DE CAMBIO

Fabricado en acero de alta resistencia, con estría laminada en frío, mecanizados en maquinaria CNC donde se controla sus medidas con precisión para garantizar su ensamble y funcionamiento en la motocicletas.



Cód. 101051

Cód. original: 1W1-18101-01

No	MARCA	APLICACIONES
1	YAMAHA	DT 175 C
2	YAMAHA	DT 175 D
3	YAMAHA	DT 175 E
4		



Cód. 101052

Cód. original: 24610-KGA-900

No	MARCA	APLICACIONES
1	HONDA	CG 125 ES
2	HONDA	CG 125 TITAN ES
3	HONDA	NXR 125 BROSS
4	HONDA	XR 125 BRIO



Cód. 101053

Cód. original: 3M5-18101-01

No	MARCA	APLICACIONES
1	YAMAHA	RX 115 / RX 115 S
2	YAMAHA	RX 125
3	YAMAHA	RX 135
4	YAMAHA	RXZ 135



Cód. 101054

Cód. original: 164-18101-02

No	MARCA	APLICACIONES
1	YAMAHA	FURIA FS 80
2		
3		
4		



Cód. 101055

Cód. original: 25510-39100

No	MARCA	APLICACIONES
1	SUZUKI	GP 125
2	SUZUKI	TS 125 ER
3		
4		



Cód. 101056

Cód. original: 25510-29300

No	MARCA	APLICACIONES
1	SUZUKI	TS 185 ER
2		
3		
4		



Cód. 101057

Cód. original: 25510-30D00

No	MARCA	APLICACIONES
1	SUZUKI	FD 115 VIVA F.D.
2	SUZUKI	VIVA X 115
3		
4		



Cód. 101058

Cód. original: 2R81810100

No	MARCA	APLICACIONES
1	YAMAHA	RD 250
2	YAMAHA	RD 350
3	YAMAHA	RD 400
4		



Cód. 101059

Cód. original: 25510-48700

No	MARCA	APLICACIONES
1	SUZUKI	TS 125 CR
2	SUZUKI	TS 125 ER
3	SUZUKI	TS 125 X
4		



Cód. 1010510

Cód. original: 25510-12100

No	MARCA	APLICACIONES
1	SUZUKI	A 100
2	SUZUKI	AX 100
3	SUZUKI	AX 115
4		



Cód. 1010511

Cód. original: 4F2-18101-00

No	MARCA	APLICACIONES
1	YAMAHA	DT 125 D / DT 125 DS
2	YAMAHA	DTK 125
3	YAMAHA	DT 175 E / DT 175 F / DTK 175
4		



Cód. 1010512

Cód. original: 276-18101-01

No	MARCA	APLICACIONES
1	YAMAHA	RX 100
2	YAMAHA	RX 100 INDU
3	YAMAHA	RX 100 JAPON
4		



Cód. 1010513

Cód. original: 24610-098-730

No	MARCA	APLICACIONES
1	HONDA	C 70
2	HONDA	C 90
3	HONDA	C 90 E
4		



Cód. 1010514

Cód. original: 1979-1985

No	MARCA	APLICACIONES
1	HONDA	XL 185
2		
3		
4		



Cód. 1010515

Cód. original: 1986-1999

No	MARCA	APLICACIONES
1	HONDA	XL 185
2		
3		
4		



Cód. 1010516

Cód. original: 58H-18101-04

No	MARCA	APLICACIONES
1	YAMAHA	V 80
2	YAMAHA	PW 80
3		
4		



Cód. 1010517

Cód. original: 25510-35302

No	MARCA	APLICACIONES
1	SUZUKI	FR 80
2	SUZUKI	FR 100
3		
4		



Cód. 1010518

Cód. original: 4ST-18101-01

No	MARCA	APLICACIONES
1	YAMAHA	CRYPTON 110 EZ
2	YAMAHA	T 110 CRYPTON
3	YAMAHA	T 110 ED CRYPTON
4		



Cód. 1010519

Cód. original: 24610-107-760

No	MARCA	APLICACIONES
1	HONDA	XL 125 TRAIL
2	HONDA	XLR 125
3	HONDA	XLR 125 BRASIL
4	HONDA	XLR 125 TT



Cód. 1010520

Cód. original: 24610-GN5-910

No	MARCA	APLICACIONES
1	HONDA	C 100 BIZ ES
2		
3		
4		



Cód. 1010522

Cód. original: DD-1013-36

No	MARCA	APLICACIONES
1	BAJAJ	BOXER CARGO CT 100
2	BAJAJ	BOXER CT 100
3	BAJAJ	PLATINO 100
4	BAJAJ	CALIBER 115



Cód. 1010523

Cód. original: DH-1017-05

No	MARCA	APLICACIONES
1	BAJAJ	PULSAR 180 II
2	BAJAJ	PULSAR UG 180
3	BAJAJ	PULSAR 220 F
4		



Cód. 1010524

Cód. original: 192330002

No	MARCA	APLICACIONES
1	AKT	AK 125 SL
2	AKT	AK 125 TT
3	AKT	AK 150 TT
4	AKT	EVO R3



Cód. 1010525

Cód. original: 25510-05220-000

No	MARCA	APLICACIONES
1	SUZUKI	GN 125
2	SUZUKI	GSX R 150
3	SUZUKI	GN 125 H
4	SUZUKI	GN 125 NOVA



Cód. 1010527

Cód. original: 24610GF6000

No	MARCA	APLICACIONES
1	HONDA	ECO 100
2	HONDA	ECO 100 PLUS
3		
4		



Cód. 1010528

Cód. original: 24610-KWS-900

No	MARCA	APLICACIONES
1	HONDA	CB 1 - CB 110
2	HONDA	CB 110 DLX
3	HONDA	CB 125 F
4	HONDA	CB 125 F DLX



Cód. 1010529

Cód. original: 24610-KST-940

No	MARCA	APLICACIONES
1	HERO	ECO 100 - ECO DELUXE FE 100
2	HERO	ECO DELUXE 3S - PASSION PRO 100
3	HERO	SPLENDOR I SMART 110 FE
4	HERO	SPLENDOR X PRO-IBS



Cód. 1010530

Cód. original: 24610-KSP-910

No	MARCA	APLICACIONES
1	HERO	HUNK 150 - HUNK 160 4V - HUNK 160 R
2	HERO	HUNK 190 - THRILLER 150 - THRILLER 200 R
3	HERO	THRILLER SPORT 150 - X PULSE 200 / T
4	HONDA	CBF 125 - CBF 150



- Bandas de freno *Premium*
- Pastillas **JAPAN** *Premium Organics*
- Pastillas **JAPAN** *Premium Semimetallics*
- Pastillas **JAPAN** *Racing*
- Pastillas **JAPAN** *COMPETITION PRO*
- Pastillas **JAPAN** *Bike*
- Maniguetas
- Bases de Espejo
- Conjunto Base + Manigueta
- Discos de Freno
- Reposapiés
- Ejes de Rueda
- Ejes de Cambio
- Varillas de Freno
- Cuñas
- Pedales de Encendido
- Pedales de Cambio
- Pedales de Freno
- Tornillos
- Resortes de Banda
- Otros Productos
- Rines **Murelli**

Industrias Japan S.A



INDUSTRIAS JAPAN S.A.
Fabricantes de partes para motocicletas

Live safely





La fabricación es definida bajo el mecanismo integral del sistema de frenos, JAPAN utiliza procesos automáticos de corte y aceros de alta resistencia para asegurar que se cumplan todas las especificaciones de la motocicleta, garantizando una parte que responderá en forma óptima a la relación en la activación del sistema de frenos.

Dependiendo la referencia terminado en zincado blanco, negro y amarillo que permite crear una capa protectora frente a la corrosión. Incluye pasadores, resortes, arandelas y tuercas.

VARILLAS DE FRENO



Son fabricadas cumpliendo especificaciones de dureza y dimensiones exactas que garantizan un ajuste perfecto en el ensamble del sistema de embrague y/o el volante magnético.

CUÑAS



VARILLAS DE FRENO



JAPAN

Frenos de Alto Desempeño

CUÑAS (CHAVETAS)

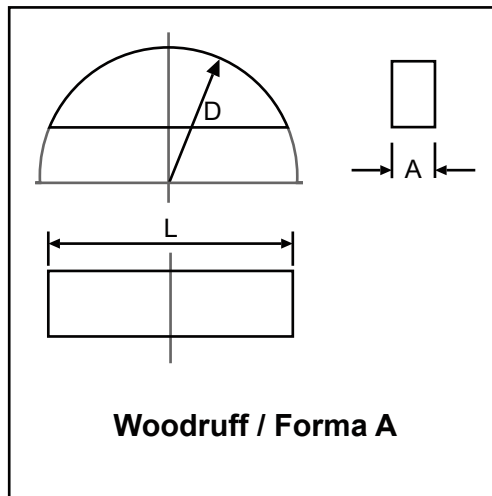

Woodruff / Forma A

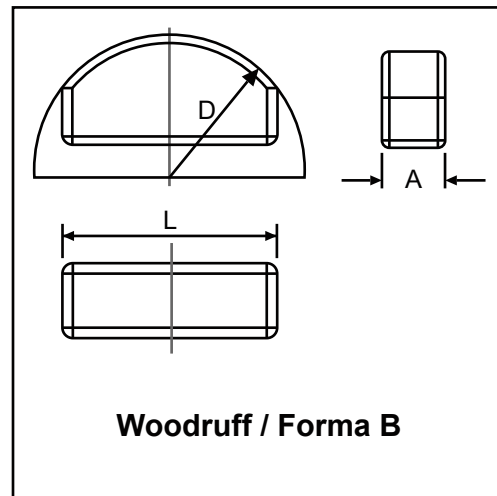

Woodruff / Forma B

CUÑA WOODRUFF				
CÓDIGO	D	A	L	FORMA
101041	12.7	3.0	12.3	A
101042	16.0	3.0	14.4	A
101043	21.4	3.0	12.9	A
101044	13.2	3.0	10.0	B
101045	16.2	4.0	13.0	B
101046	25.4	4.0	14.0	B
101048	19.4	5.0	15.0	B

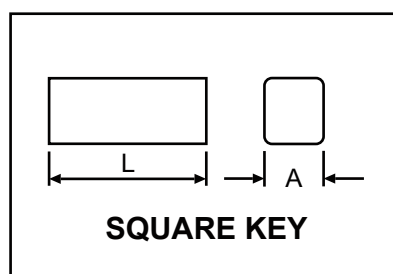

SQUARE KEY

SQUARE KEY		
CÓDIGO	L	A
101047	12.5	5



Cód. **101561**

Cód. original: 43300-23450-000

No	MARCA	APLICACIONES
1	SUZUKI	AX 100
2	SUZUKI	AX 115
3		
4		



Cód. **101562**

Cód. original: 18A-27231-IJ

No	MARCA	APLICACIONES
1	YAMAHA	V 80
2		
3		
4		



Cód. **101563**

Cód. original: 43300-25000

No	MARCA	APLICACIONES
1	SUZUKI	FR 80
2	SUZUKI	FR 100
3		
4		



Cód. **101564**

Cód. original: 43300-48700

No	MARCA	APLICACIONES
1	SUZUKI	TS 125 ER
2	SUZUKI	TS 125 X
3	SUZUKI	TS 125 X CR
4	SUZUKI	TS 185 ER



Cód. **101565**

Cód. original: 40X-27231-IJ

No	MARCA	APLICACIONES
1	YAMAHA	FURIA FS 80
2	YAMAHA	YB 100
3	YAMAHA	T 110 CRYPTON
4		



Cód. **101566**

Cód. original: 43451-397-000

No	MARCA	APLICACIONES
1	HONDA	C 70
2	HONDA	C 90
3	HONDA	C 90 E
4		



Cód. **101567**

Cód. original: 43011-010-IJ

No	MARCA	APLICACIONES
1	KAWASAKI	AN 80 G2 JOY
2	KAWASAKI	K 90
3		
4		



Cód. **101568**

Cód. original: 43011-A004-IJ

No	MARCA	APLICACIONES
1	KAWASAKI	KTZ 100
2	KAWASAKI	GTO 125
3	KAWASAKI	KB 125
4		



Cód. **101569**

Cód. original: 337-27231-IJ

No	MARCA	APLICACIONES
1	KAWASAKI	G7 100
2	YAMAHA	RX 100 / RX 100 INDU / RX 100 JAPON
3	YAMAHA	RX 115 / RX 115 S
4	YAMAHA	



Cód. **1015610**

Cód. original: 43451-KRE-900

No	MARCA	APLICACIONES
1	HONDA	NXR 125 BROSS
2	HONDA	XR 125 L
3	HONDA	XR 150 L
4		



Cód. **1015611**

Cód. original: 18G-27231-00

No	MARCA	APLICACIONES
1	BAJAJ	PLATINO 125 DTSI
2	YAMAHA	DT 125 D / DT 125 DS / DTK 125 / DTK 175
3	YAMAHA	DT 175 / DT 175 C / DT 175 D / DT 175 E / DT 175 F
4		



Cód. **1015612**

Cód. original: 43010-1085

No	MARCA	APLICACIONES
1	KAWASAKI	VICTOR M 150
2		
3		
4		



Cód. 1015613

Cód. original: 31-1910-16-IJ

No	MARCA	APLICACIONES
1	BAJAJ	BOXER CARGO CT 100
2	BAJAJ	BOXER CT 100
3		
4		



Cód. 1015614

Cód. original: 43451-KRF-900

No	MARCA	APLICACIONES
1	HONDA	CGL 125
2	YAMAHA	CRYPTON 115
3	YAMAHA	CRYPTON FI
4		



Cód. 1015615

Cód. original: 43451-437-IJ

No	MARCA	APLICACIONES
1	HONDA	XL 185
2	SIGMA	SG 100 5A
3		
4		



Cód. 1015617

Cód. original: 5VA-F7231-00

No	MARCA	APLICACIONES
1	YAMAHA	LIBERO 110
2	YAMAHA	LIBERO 125
3		
4		



Cód. 1015618

Cód. original: 5YY-F7231-00

No	MARCA	APLICACIONES
1	YAMAHA	YBR 125 DX
2	YAMAHA	YBR 125 ESD
3	YAMAHA	LIBERO 125
4		



Cód. 1015619

Cód. original: DJ-1910-10

No	MARCA	APLICACIONES
1	BAJAJ	PULSAR 150
2	BAJAJ	PULSAR 180 / PULSAR 180 II
3	BAJAJ	PULSAR BLACK TEC 180
4	BAJAJ	PULSAR DTSI 180 / PULSAR UG 180



Cód. 1015620

Cód. original: 43311-05310-000

No	MARCA	APLICACIONES
1	SUZUKI	EN 125
2	SUZUKI	GN 125 / GN 125 E / GN 125 H
3	SUZUKI	GN 125 NOVA
4	SUZUKI	GS 125



Cód. 1015621

Cód. original: 43300-30D00-000

No	MARCA	APLICACIONES
1	SUZUKI	FD 115 VIVA F.D.
2	SUZUKI	VIVA X 115
3		
4		



Cód. 1015623

Cód. original: 2901050119

No	MARCA	APLICACIONES
1	AKT	AK 125 SL
2	AKT	AK 125 NKDR
3	AKT	CR5 180
4	AKT	NKD EX 75



Cód. 1015624

Cód. original: 43451-KRS-830

No	MARCA	APLICACIONES
1	AKT	AK SPECIAL 110
2	HONDA	C 100 WAVE I
3	HONDA	C 100 WAVE II
4		



Cód. 1015625

Cód. original: 43300-42A02

No	MARCA	APLICACIONES
1	SUZUKI	DR 200
2		
3		
4		



Cód. 1015626

Cód. original: 52200-I111-0000

No	MARCA	APLICACIONES
1	CHINA	YUMBO DAKAR 200
2		
3		
4		



Cód. 1015627

Cód. original: DS-1910-03

No	MARCA	APLICACIONES
1	BAJAJ	DISCOVER 125 / DISCOVER 125 DTSI
2	BAJAJ	PULSAR 125 +
3	BAJAJ	PULSAR NS 125
4	BAJAJ	PULSAR AS 150



Cód. 1015633

Cód. original: 43451-KTE-910

No	MARCA	APLICACIONES
1	HONDA	CB 110
2		
3		
4		



Cód. 1015634

Cód. original: 43451-KWF-900

No	MARCA	APLICACIONES
1	HONDA	CBF 125
2		
3		
4		



Cód. 1015636

Cód. original: 43451-KCC-900

No	MARCA	APLICACIONES
1	HERO	CD 100 SPLENDOR
2	HONDA	ECO 100
3	HONDA	ECO 100 PLUS
4		



Cód. 1015655

Cód. original: 45D-F7231-00

No	MARCA	APLICACIONES
1	YAMAHA	FZ 16
2	YAMAHA	FZ 16 ST FAZER
3		
4		



Cód. 1015650

Cód. original: 43451-KBB-950

No	MARCA	APLICACIONES
1	HONDA	XL 200
2		
3		
4		



- Bandas de freno *Premium*
- Pastillas **JAPAN** *Premium Organics*
- Pastillas **JAPAN** *Premium Semimetallics*
- Pastillas **JAPAN** *Racing*
- Pastillas **JAPAN** *COMPETITION PRO*
- Pastillas **JAPAN** *Bike*
- Maniguetas
- Bases de Espejo
- Conjunto Base + Manigueta
- Discos de Freno
- Reposapiés
- Ejes de Rueda
- Ejes de Cambio
- Varillas de Freno
- Cuñas
- Pedales de Encendido
- Pedales de Cambio
- Pedales de Freno
- Tornillos
- Resortes de Banda
- Otros Productos
- Rines **Murelli**

Industrias Japan S.A



INDUSTRIAS JAPAN S.A.
Fabricantes de partes para motocicletas

Live safely





La fabricación es definida bajo el mecanismo integral del sistema de frenos, JAPAN utiliza procesos automáticos de corte y aceros de alta resistencia para asegurar que se cumplan todas las especificaciones de la motocicleta, garantizando una parte que responderá en forma óptima a la relación en la activación del sistema de frenos.

Dependiendo la referencia terminado en zincado blanco, negro y amarillo que permite crear una capa protectora frente a la corrosión. Incluye pasadores, resortes, arandelas y tuercas.

VARILLAS DE FRENO



Son fabricadas cumpliendo especificaciones de dureza y dimensiones exactas que garantizan un ajuste perfecto en el ensamble del sistema de embrague y/o el volante magnético.

CUÑAS

CUÑAS



JAPAN
Frenos de Alto Desempeño

CUÑAS



JAPAN
Frenos de Alto Desempeño



Cód. **101041**

Cód. original: 90280-03017

No	MARCA	APLICACIONES
1	YAMAHA	CY 50 JOG / LB 80 CHAPPY / PW 80 / V 80 / AXIS 90
2	YAMAHA	BWS 100 / DT 100 / DT 100 K / RX 100 / RX 100 INDU
3	YAMAHA	RX 100 JAPON / CRYPTON / T 110 EZ / LIBERO 110
4	YAMAHA	T 110 CRYPTON / T 110 ED CRYPTON / YC Z 110
5	YAMAHA	CRYPTON 115 / CRYPTON FI / FINO AF 115 F
6	YAMAHA	FINO AF 115 S / RX 115 / RX 115 S / DT 125 / DT 125 D



Cód. **101042**

Cód. original: -

No	MARCA	APLICACIONES
1	UNIVERSAL	UNIVERSAL
2		
3		
4		



Cód. **101043**

Cód. original: 90741-035-000

No	MARCA	APLICACIONES
1	HONDA	C 70
2	HONDA	C 90
3	HONDA	C 90 E
4		



Cód. **101044**

Cód. original: 08341-31039

No	MARCA	APLICACIONES
1	SUZUKI	TS 125 ER - GIXXER SF 150 ABS
2	SUZUKI	TS 125 X - GIXXER SF 150 FI
3	SUZUKI	TS 125 X CR - GN 125 H - GN 125 NOVA
4		R - GN 125 H - GN 125 NOVA R - GN 125 H - GN 125 NOVA R - GN 125 H - GN 125 NOVA



Cód. **101045**

Cód. original: 08341-31049

No	MARCA	APLICACIONES
1	SUZUKI	TS 100
2		
3		
4		



Cód. **101046**

Cód. original: 90701-HB6-010

No	MARCA	APLICACIONES
1	HONDA	XL 185
2	HONDA	CRF 100 F
3	HONDA	CRF 110 F
4	HONDA	TRX 250 X FOURTRAX - TRX 300 X

CUÑAS DE CLUTCH



Cód. **101047**

Cód. original: 90282-05005

No	MARCA	APLICACIONES
1	YAMAHA	DT 125 D / DT 125 DS / DTK 125 / DT 175 C
2	YAMAHA	DT 175 D / DT 175 E / DT 175 F / DTK 175
3		
4		



Cód. **101048**

Cód. original: 08341-31059

No	MARCA	APLICACIONES
1	SUZUKI	TS 100
2	SUZUKI	TS 125 ER
3	SUZUKI	TS 125 X
4	SUZUKI	TS 125 X CR



- Bandas de freno *Premium*
- Pastillas **JAPAN** *Premium Organics*
- Pastillas **JAPAN** *Premium Semimetallics*
- Pastillas **JAPAN** *Racing*
- Pastillas **JAPAN** *COMPETITION PRO*
- Pastillas **JAPAN** *Bike*
- Maniguetas
- Bases de Espejo
- Conjunto Base + Manigueta
- Discos de Freno
- Reposapiés
- Ejes de Rueda
- Ejes de Cambio
- Varillas de Freno
- Cuñas
- Pedales de Encendido
- Pedales de Cambio
- Pedales de Freno
- Tornillos
- Resortes de Banda
- Otros Productos
- Rines **Murelli**

Industrias Japan S.A



INDUSTRIAS JAPAN S.A.
Fabricantes de partes para motocicletas

Live safely





Fabricado con los más estrictos estándares de calidad, forjado por estampa en caliente que garantiza una alta resistencia mecánica. Mecanizado en CNC para lograr medidas exactas dan como resultado un producto de larga vida y excelente funcionalidad. Dependiendo la referencia terminado en zincado blanco, negro y cromado.

PEDALES DE ENCENDIDO



Fabricado en acero de alta resistencia y componente estriado de exigente precisión, garantiza un ajuste preciso en el eje, cumpliendo con un perfecto comando de accionamiento del sistema de cambios de la motocicleta prolongando su vida útil.

Dependiendo la referencia terminado en zincado verde o blanco.

PEDALES DE CAMBIO



Desarrollado con estrictas especificaciones de calidad que garantizan un funcionamiento confiable y de larga duración para el desempeño que la motocicleta exige. Dependiendo la referencia terminado en zincado blanco, negro y cromado.

PEDALES DE FRENO

PEDALES DE ENCENDIDO



JAPAN
Frenos de Alto Desempeño

PEDALES DE ENCENDIDO



JAPAN
Frenos de Alto Desempeño



Cód. 101392 ZINCADO NEGRO

Cód. original: 2A6-15620-02

No	MARCA	APLICACIONES
1	YAMAHA	DT 125 D / DT 125 DS / DTK 125 / DTK 175
2	YAMAHA	DT 175 C / DT 175 D / DT 175 E / DT 175 F
3		
4		



Cód. 101393 ZINCADO BLANCO

Cód. original: 4X8-15620-00

No	MARCA	APLICACIONES
1	YAMAHA	RX 100 / RX 100 INDU / RX 100 JAPON
2	YAMAHA	RX 115 / RX 115 S
3	YAMAHA	RX 125 / RX 135 / RXZ 135
4		



Cód. 101394 ZINCADO BLANCO

Cód. original: 26300-35301

No	MARCA	APLICACIONES
1	SUZUKI	FR 80
2	SUZUKI	FR 100
3		
4		



Cód. 101395 ZINCADO BLANCO

Cód. original: 26300-23400

No	MARCA	APLICACIONES
1	SUZUKI	AX 100
2	SUZUKI	AX 115
3	SUZUKI	GP 125
4	SUZUKI	TR 125



Cód. 101396 ZINCADO BLANCO

Cód. original: 28300-KGA-900

No	MARCA	APLICACIONES
1	HONDA	CG 125 TITAN
2	HONDA	CG 125 TITAN KS
3	JIALING	JL PEGASO
4		



Cód. 101398 ZINCADO NEGRO

Cód. original: 26300-29303

No	MARCA	APLICACIONES
1	SUZUKI	TS 100
2		
3		
4		



Cód. 101399 ZINCADO BLANCO

Cód. original: 5T9-15620-00

No	MARCA	APLICACIONES
1	YAMAHA	PW 80
2	YAMAHA	V 80
3		
4		



Cód. 1013912 ZINCADO BLANCO

Cód. original: 28300-KST-920

No	MARCA	APLICACIONES
1	HONDA	CD 100
2	HONDA	ECO 100
3	TVS	STAR SPORT 100
4		



Cód. 1013917 CROMO

Cód. original: 28300-383-670

No	MARCA	APLICACIONES
1	AKT	AK 125 SL
2	HONDA	CG 125
3		
4		



Cód. 1013918 CROMO

Cód. original: DU-1010-50

No	MARCA	APLICACIONES
1	BAJAJ	BOXER CARGO CT 100
2	BAJAJ	BOXER CT 100
3	BAJAJ	PLATINO 100
4	BAJAJ	PLATINO 100 SPORT



Cód. 1013911 ZINCADO AZUL

Cód. original: 28300-GCE-900

No	MARCA	APLICACIONES
1	HONDA	C 100 BIZ ES
2	HONDA	C 90
3	HONDA	C 90 E
4		



Cód. 1013916 ZINCADO AZUL

Cód. original: 28300-KFC-900

No	MARCA	APLICACIONES
1	HONDA	NXR 125 BROSS
2	HONDA	XLR 125
3	HONDA	XLR 125 BRASIL
4	HONDA	XLR 125 TT

PEDALES DE ENCENDIDO



JAPAN
Frenos de Alto Desempeño



Cód. **1013914**

ZINCADO AZUL



Cód. **1013919**

ZINCADO NEGRO

Cód. original: 28300-141-640

No	MARCA	APLICACIONES
1	HONDA	C 70
2		
3		
4		

Cód. original: 46300-625

No	MARCA	APLICACIONES
1	AYCO	MOTOCARRO AY 250 ZH-2
2		
3		
4		



- Bandas de freno *Premium*
- Pastillas **JAPAN** *Premium Organics*
- Pastillas **JAPAN** *Premium Semimetallics*
- Pastillas **JAPAN** *Racing*
- Pastillas **JAPAN** *COMPETITION PRO*
- Pastillas **JAPAN** *Bike*
- Maniguetas
- Bases de Espejo
- Conjunto Base + Manigueta
- Discos de Freno
- Reposapiés
- Ejes de Rueda
- Ejes de Cambio
- Varillas de Freno
- Cuñas
- Pedales de Encendido
- Pedales de Cambio
- Pedales de Freno
- Tornillos
- Resortes de Banda
- Otros Productos
- Rines **Murelli**

Industrias Japan S.A



INDUSTRIAS JAPAN S.A.
Fabricantes de partes para motocicletas

Live safely





Fabricado con los más estrictos estándares de calidad, forjado por estampa en caliente que garantiza una alta resistencia mecánica. Mecanizado en CNC para lograr medidas exactas dan como resultado un producto de larga vida y excelente funcionalidad. Dependiendo la referencia terminado en zincado blanco, negro y cromado.

PEDALES DE ENCENDIDO



Fabricado en acero de alta resistencia y componente estriado de exigente precisión, garantiza un ajuste preciso en el eje, cumpliendo con un perfecto comando de accionamiento del sistema de cambios de la motocicleta prolongando su vida útil.

Dependiendo la referencia terminado en zincado verde o blanco.

PEDALES DE CAMBIO



Desarrollado con estrictas especificaciones de calidad que garantizan un funcionamiento confiable y de larga duración para el desempeño que la motocicleta exige. Dependiendo la referencia terminado en zincado blanco, negro y cromado.

PEDALES DE FRENO

PEDALES DE CAMBIO



JAPAN
Frenos de Alto Desempeño

PEDALES DE CAMBIO



JAPAN
Frenos de Alto Desempeño



Cód. **101071** ZINCADO VERDE

Cód. original: 2A6-18111-00

No	MARCA	APLICACIONES
1	YAMAHA	DT 125 D / DT 125 DS / DTK 125
2	YAMAHA	DT 175 C / DT 175 D / DT 175 E
3	YAMAHA	DT 175 F / DTK 175
4		



Cód. **101072** ZINCADO VERDE

Cód. original: 1T9-18111-00

No	MARCA	APLICACIONES
1	YAMAHA	DT 100
2		
3		
4		



Cód. **101073** ZINCADO VERDE

Cód. original: 25600-29300

No	MARCA	APLICACIONES
1	SUZUKI	TS 100
2	SUZUKI	TR 125
3	SUZUKI	TS 185 ER
4		



Cód. **101074** ZINCADO VERDE

Cód. original: 13156-053

No	MARCA	APLICACIONES
1	KAWASAKI	GT 100
2	KAWASAKI	KV 100
3	KAWASAKI	KE 125 A
4		



Cód. **101075** ZINCADO VERDE

Cód. original: 24700-437-000

No	MARCA	APLICACIONES
1	HONDA	XL 100
2	HONDA	XL 185
3		
4		



Cód. **101076** ZINCADO BLANCO

Cód. original: 25600-23400

No	MARCA	APLICACIONES
1	SUZUKI	A 80
2	SUZUKI	A 100
3	SUZUKI	AX 100
4	SUZUKI	AX 115



Cód. **101077** ZINCADO BLANCO

Cód. original: 25610-35500

No	MARCA	APLICACIONES
1	SUZUKI	FR 80
2	SUZUKI	FR 100
3		
4		



Cód. **101078** ZINCADO VERDE

Cód. original: 25600-48700

No	MARCA	APLICACIONES
1	SUZUKI	TS 125 ER
2	SUZUKI	TS 125 X
3		
4		



Cód. **101070** ZINCADO VERDE

Cód. original: 24700-KBZ-940

No	MARCA	APLICACIONES
1	HONDA	XLR 125
2	HONDA	XLR 125 BRASIL
3	HONDA	XLR 125 TT
4	HONDA	XR 200



Cód. **1010711** ZINCADO BLANCO

Cód. original: 24701-086-720

No	MARCA	APLICACIONES
1	HONDA	C 70
2	HONDA	C 90
3	HONDA	C 90 E
4		



Cód. **1010712** ZINCADO BLANCO

Cód. original: 59L-18111-00

No	MARCA	APLICACIONES
1	YAMAHA	V 80
2		
3		
4		



Cód. **1010713** ZINCADO NEGRO

Cód. original: 55K-18111-00

No	MARCA	APLICACIONES
1	YAMAHA	RXZ 135
2		
3		
4		

PEDALES DE CAMBIO



JAPAN
Frenos de Alto Desempeño



Cód. **1010714** ZINCADO BLANCO

Cód. original: 5VA-E8111-00

No	MARCA	APLICACIONES
1	YAMAHA	RX 100
2	YAMAHA	RX 100 INDU
3	YAMAHA	RX 100 JAPON
4		



Cód. **1010716** ZINCADO BLANCO

Cód. original: 4JF-E8111-10

No	MARCA	APLICACIONES
1	YAMAHA	RX 115 S
2		
3		
4		



Cód. **1010718** ZINCADO BLANCO

Cód. original: DD-1014-95

No	MARCA	APLICACIONES
1	BAJAJ	BOXER CARGO CT 100
2	BAJAJ	BOXER CT 100
3	BAJAJ	PLATINO 100
4		



Cód. **1010721** ZINCADO BLANCO

Cód. original: 25610-09G01-000

No	MARCA	APLICACIONES
1	SUZUKI	FD 115 VIVA F.D.
2	SUZUKI	VIVA X 115
3	SUZUKI	BEST 125
4		



Cód. **1010724** ZINCADO BLANCO

Cód. original: 24700-KST-900

No	MARCA	APLICACIONES
1	HONDA	CD 100
2	HONDA	ECO 100
3		
4		



Cód. **1010725** ZINCADO BLANCO

Cód. original: 2N3-18111-00

No	MARCA	APLICACIONES
1	YAMAHA	FURIA FS 80
2		
3		
4		



Cód. **1010726** ZINCADO BLANCO

Cód. original: 25600-01D02

No	MARCA	APLICACIONES
1	SUZUKI	GS 500 E
2	SUZUKI	GS 500 E MODELO ANTIGUO
3	SUZUKI	GS 500 K1
4		



Cód. **1010727** ZINCADO BLANCO

Cód. original: 13242-1079

No	MARCA	APLICACIONES
1	KAWASAKI	AN 80 G2 JOY
2	KAWASAKI	NEOMAX 100
3		
4		



Cód. **1010732** ZINCADO BLANCO

Cód. original: 25600-05320

No	MARCA	APLICACIONES
1	SUZUKI	GN 125 / GN 125 E
2	SUZUKI	GN 125 H / GN 125 NOVA
3	SUZUKI	INTRUDER 125
4	SUZUKI	



Cód. **1010735** ZINCADO NEGRO

Cód. original: 5VK-E8110-00

No	MARCA	APLICACIONES
1	YAMAHA	XT 660 R
2		
3		
4		



Cód. **1010736** ZINCADO BLANCO

Cód. original: 4ST-E8111-00

No	MARCA	APLICACIONES
1	YAMAHA	T 110 CRYPTON
2		
3		
4		



Cód. **1010740** ZINCADO BLANCO

Cód. original: 22P-E8111-00

No	MARCA	APLICACIONES
1	YAMAHA	YBR 125 DX
2		
3		
4		

PEDALES DE CAMBIO



JAPAN
Frenos de Alto Desempeño



Cód. **1010741** ZINCADO BLANCO

Cód. original: 5C9-E8110-00

No	MARCA	APLICACIONES
1	YAMAHA	LIBERO 110
2	YAMAHA	YBR 125 E
3		
4		



Cód. **1010742** ZINCADO BLANCO

Cód. original: 24710-KRE-900

No	MARCA	APLICACIONES
1	HONDA	NXR 125 BROSS
2	HONDA	XR 125 L
3	HONDA	XR 150 L
4		



Cód. **1010743** ZINCADO BLANCO

Cód. original: DH-1011-65

No	MARCA	APLICACIONES
1	BAJAJ	PULSAR 150
2	BAJAJ	PULSAR 180
3	BAJAJ	PULSAR 180 II
4	BAJAJ	PULSAR BLACK TEC 180 / PULSAR DTSI 180



Cód. **1010744** ZINCADO BLANCO

Cód. original: 24701-397-000

No	MARCA	APLICACIONES
1	AKT	AK 125 SL
2	HONDA	CG 125 TITAN
3	HONDA	CG 125 TITAN KS
4		



Cód. **1010749** ZINCADO BLANCO

Cód. original: 08370-J01FP0001

No	MARCA	APLICACIONES
1	KEEWAY	EMPIRE HORSE 150
2		
3		
4		



Cód. **1010755** ZINCADO NEGRO

Cód. original: 24701-KWS-900

No	MARCA	APLICACIONES
1	HONDA	CB 110
2		
3		
4		



Cód. **1010756** ZINCADO NEGRO

Cód. original: 45600-620-N00

No	MARCA	APLICACIONES
1	AYCO	MOTOCARRO AYCO 200
2	AYCO	MOTOCARRO FORCE 250
3		
4		



Cód. **1010793** ZINCADO AMARILLO

Cód. original: 45601-625

No	MARCA	APLICACIONES
1	AYCO	AY 250 ZH-3
2		
3		
4		



Cód. **101251** ZINCADO VERDE
ARTICULADO

Cód. original: 2A6-18111-IJ



Cód. **101253** ZINCADO VERDE
ARTICULADO

Cód. original: 25600-29300-IJ

No	MARCA	APLICACIONES
1	SUZUKI	TS 100
2	SUZUKI	TS 125 ER
3	SUZUKI	TS 125 X
4	SUZUKI	TS 125 X CR



Cód. **101259** ZINCADO VERDE
ARTICULADO

Cód. original: 1VJ-18110-01

No	MARCA	APLICACIONES
1	YAMAHA	XT 600
2	YAMAHA	XT 600 E
3		
4		



Cód. **101273** MUÑO PEDAL
DE CAMBIOS

Cód. original: 4X8-18112-00

No	MARCA	APLICACIONES
1	YAMAHA	RX 100
2	YAMAHA	RX 100 INDU
3	YAMAHA	RX 100 JAPON
4	YAMAHA	RX 115 S

PEDALES DE CAMBIO



JAPAN
Frenos de Alto Desempeño



Cód. 1012510 ZINCADO VERDE
ARTICULADO

Cód. original: 2CD-E8110-U

No	MARCA	APLICACIONES
1	YAMAHA	YBR 125 ESD
2		
3		
4		



Cód. 101553 CONJUNTO EXTENSIÓN
PEDAL DE CAMBIOS

Cód. original: 4JF-E8111-IJ

No	MARCA	APLICACIONES
1	YAMAHA	RX 115 S
2		
3		
4		



Cód. 101554 CONJUNTO EXTENSIÓN
PALANCA DE CAMBIOS

Cód. original: 5VA-E8111-IJ

No	MARCA	APLICACIONES
1	YAMAHA	RX 100
2	YAMAHA	RX 100 INDU
3	YAMAHA	RX 100 JAPON
4		



Cód. 1015512 CONJUNTO EXTENSIÓN
PEDAL DE CAMBIOS

Cód. original: 25061-45F00-000

No	MARCA	APLICACIONES
1	SUZUKI	EN 125
2	SUZUKI	GS 125
3		
4		



Cód. 1015514 CONJUNTO PEDAL
CAMBIOS DE MOTOCARRO

Cód. original: 45600-625-N00

No	MARCA	APLICACIONES
1	AYCO	MOTOCARRO AY 250 ZH-2
2		
3		
4		



Cód. 1015515 CONJUNTO PEDAL
CAMBIOS DE MOTOCARRO

Cód. original: 45600-630-N00

No	MARCA	APLICACIONES
1	AYCO	MOTOCARRO AY 250 ZH-3
2		
3		
4		



Cód. 1010733 ZINCADO AZUL

Cód. original: N/A

No	MARCA	APLICACIONES
1	LIFAN	LF 125
2		
3		
4		



Cód. 1010757 ZINCADO AZUL

Cód. original: 21C-E8111-00

No	MARCA	APLICACIONES
1	YAMAHA	FZ 16
2	YAMAHA	FZ 16 2.0
3	YAMAHA	FZ 16 ST FAZER
4		



Cód. 1010792 ZINCADO AMARILLO

Cód. original: N/A

No	MARCA	APLICACIONES
1	AYCO	MOTOCARRO AY 250 ZH
2		
3		
4		



- Bandas de freno *Premium*
- Pastillas **JAPAN** *Premium Organics*
- Pastillas **JAPAN** *Premium Semimetallics*
- Pastillas **JAPAN** *Racing*
- Pastillas **JAPAN** *COMPETITION PRO*
- Pastillas **JAPAN** *Bike*
- Maniguetas
- Bases de Espejo
- Conjunto Base + Manigueta
- Discos de Freno
- Reposapiés
- Ejes de Rueda
- Ejes de Cambio
- Varillas de Freno
- Cuñas
- Pedales de Encendido
- Pedales de Cambio
- Pedales de Freno
- Tornillos
- Resortes de Banda
- Otros Productos
- Rines **Murelli**

Industrias Japan S.A



INDUSTRIAS JAPAN S.A.
Fabricantes de partes para motocicletas

Live safely





Fabricado con los más estrictos estándares de calidad, forjado por estampa en caliente que garantiza una alta resistencia mecánica. Mecanizado en CNC para lograr medidas exactas dan como resultado un producto de larga vida y excelente funcionalidad. Dependiendo la referencia terminado en zincado blanco, negro y cromado.

PEDALES DE ENCENDIDO



Fabricado en acero de alta resistencia y componente estriado de exigente precisión, garantiza un ajuste preciso en el eje, cumpliendo con un perfecto comando de accionamiento del sistema de cambios de la motocicleta prolongando su vida útil.

Dependiendo la referencia terminado en zincado verde o blanco.

PEDALES DE CAMBIO



Desarrollado con estrictas especificaciones de calidad que garantizan un funcionamiento confiable y de larga duración para el desempeño que la motocicleta exige. Dependiendo la referencia terminado en zincado blanco, negro y cromado.

PEDALES DE FRENO

PEDALES DE FRENO



JAPAN
Frenos de Alto Desempeño

PEDALES DE FRENO



JAPAN
Frenos de Alto Desempeño



Cód. **101522** ZINCADO BLANCO

Cód. original: 46500-KRH-900

No	MARCA	APLICACIONES
1	HONDA	NXR 125 BROSS
2	HONDA	XR 125 L
3	HONDA	XR 150
4		



Cód. **101525** CROMO

Cód. original: 43110-23453

No	MARCA	APLICACIONES
1	SUZUKI	AX 100
2	SUZUKI	AX 115
3		
4		



Cód. **101529** ZINCADO BLANCO

Cód. original: DH-1910-01

No	MARCA	APLICACIONES
1	BAJAJ	PULSAR DTSI TEC
2	BAJAJ	PULSAR BLACK TEC
3		
4		



Cód. **1015211** CROMO

Cód. original: 43110-05301

No	MARCA	APLICACIONES
1	SUZUKI	GN 125 E
2	SUZUKI	GN 125 F EURO 3
3	SUZUKI	GN 125 H
4	SUZUKI	GN 125 NOVA



Cód. **1015212** CROMO

Cód. original: 291120006-0001

No	MARCA	APLICACIONES
1	AKT	AK 125 SL
2	AKT	NKD EX 75
3	AKT	AK 125 NKDR
4	AKT	NKD MASTECH



Cód. **1015213** CROMO

Cód. original: 46500-086-720

No	MARCA	APLICACIONES
1	HONDA	C70
2		
3		
4		



Cód. **1015225** CROMO

Cód. original: 43110-45F02-000

No	MARCA	APLICACIONES
1	SUZUKI	GS 125
2		
3		
4		



Cód. **1015293** ZINCADO NEGRO

Cód. original: 46500-KWF-840

No	MARCA	APLICACIONES
1	HONDA	CBF125
2		
3		
4		



Cód. **1015217** ZINCADO AZUL

Cód. original: N/A

No	MARCA	APLICACIONES
1	BAJAJ	BOXER BM 100 CLASSIC
2	BAJAJ	BOXER BM 100 CLASSIC ES
3	BAJAJ	BOXER BM 100 CLASSIC KS - BOXER CARGO CT 100
4	BAJAJ	BOXER CT 100 - CALIBER 115 - PLATINO 100

**DISPONIBLE
MUY PRONTO**

JAPAN

Cód. **101521** ZINCADO NEGRO

Cód. original: 46500-KBB-950

No	MARCA	APLICACIONES
1	HONDA	XL 200
2	HONDA	XR 200
3		
4		



- Bandas de freno *Premium*
- Pastillas **JAPAN** *Premium Organics*
- Pastillas **JAPAN** *Premium Semimetallics*
- Pastillas **JAPAN** *Racing*
- Pastillas **JAPAN** *COMPETITION PRO*
- Pastillas **JAPAN** *Bike*
- Maniguetas
- Bases de Espejo
- Conjunto Base + Manigueta
- Discos de Freno
- Reposapiés
- Ejes de Rueda
- Ejes de Cambio
- Varillas de Freno
- Cuñas
- Pedales de Encendido
- Pedales de Cambio
- Pedales de Freno
- Tornillos
- Resortes de Banda
- Otros Productos
- Rines **Murelli**

Industrias Japan S.A



INDUSTRIAS JAPAN S.A.
Fabricantes de partes para motocicletas

Live safely





INDUSTRIAS JAPAN S.A. fabrica tornillos pivote para ensamble de maniguetas y bases de espejo, así como tornillos tensores de guaya específicos para determinados modelos de motocicletas, cumpliendo las dimensiones requeridas que garantiza un ajuste ideal del producto.

TORNILLOS



INDUSTRIAS JAPAN S.A. ofrece resortes específicos para bandas de freno de motocicleta fabricados en aceros especiales y en procesos automáticos que garantizan su funcionalidad y confiabilidad.

RESORTES DE BANDA

TORNILLOS



JAPAN
Frenos de Alto Desempeño

TORNILLOS



JAPAN
Frenos de Alto Desempeño



Cód. 101111 TORNILLO MANIGUETA
ZINCADO VERDE

Cód. original: 90109-06799

No	MARCA	APLICACIONES
1	YAMAHA	DT 100 / DT 100 K / DT 125 / DT 125 D / DT 125 DS
2	YAMAHA	DTK 125 / DT 175 / DT 175 C / DT 175 D / DT 175 E
3	YAMAHA	DT 175 F / DTK 175 / DT 200 LC / DT 200 R
4	YAMAHA	DT 200 WR



Cód. 101112 TORNILLO MANIGUETA
ZINCADO BLANCO

Cód. original: 57431-11013

No	MARCA	APLICACIONES
1	SUZUKI	TR 125
2		
3		
4		



Cód. 101113 TORNILLO MANIGUETA
ZINCADO VERDE

Cód. original: 90114-428-870

No	MARCA	APLICACIONES
1	HONDA	XL 100
2	HONDA	XL 185
3		
4		



Cód. 101114 TORNILLO MANIGUETA
ZINCADO BLANCO

Cód. original: 92007-020

No	MARCA	APLICACIONES
1	KAWASAKI	KV 100
2		
3		
4		



Cód. 101115 TORNILLO TENSOR
ZINCADO VERDE

Cód. original: 90123-08046

No	MARCA	APLICACIONES
1	UNIVERSAL	UNIVERSAL
2		
3		
4		



Cód. 101116 TORNILLO MANIGUETA
ZINCADO BLANCO

Cód. original: 90113-KY0-970

No	MARCA	APLICACIONES
1	HONDA	CG 125 ES
2	HONDA	CG 125 TITAN ES
3		
4		



Cód. 101117 TORNILLO MANIGUETA
ZINCADO BLANCO

Cód. original: 57431-01011-JJ

No	MARCA	APLICACIONES
1	SUZUKI	FR 80
2	SUZUKI	AX 100
3		
4		



Cód. 101118 TORNILLO MANIGUETA
ZINCADO BLANCO

Cód. original: 90114-KFC-900

No	MARCA	APLICACIONES
1	HONDA	XLR 125
2	HONDA	XLR 125 BRASIL
3	HONDA	XLR 125 TT
4		

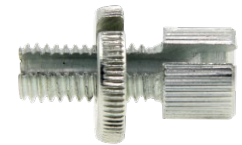

Cód. 101119 TORNILLO TENSOR
ZINCADO BLANCO

Cód. original: 53192-268-000

No	MARCA	APLICACIONES
1	HONDA	CG 125 ES
2	HONDA	CG 125 TITAN ES
3		
4		



Cód. 1011110 TORNILLO MANIGUETA
ZINCADO VERDE

Cód. original: 57431-05D00

No	MARCA	APLICACIONES
1	SUZUKI	TS 125 CR
2	SUZUKI	TS 125 X CR
3		
4		



Cód. 1011111 TORNILLO MANIGUETA
ZINCADO BLANCO

Cód. original: 57631-05D00

No	MARCA	APLICACIONES
1	SUZUKI	TS 100
2	SUZUKI	TS 125 CR
3	SUZUKI	TS 125 ER
4	SUZUKI	TS 125 X / TS 125 X CR



Cód. 1011113 TORNILLO MANIGUETA
ZINCADO VERDE

Cód. original: DL191014

No	MARCA	APLICACIONES
1	BAJAJ	BOXER CARGO CT 100
2	BAJAJ	BOXER CT 100
3	BAJAJ	PLATINO 100
4	BAJAJ	CALIBER 115

TORNILLOS



JAPAN
Frenos de Alto Desempeño

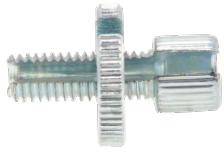

Cód. 1011151

TORNILLO TENSOR
ZINCADO BLANCO

Cód. original: 90123-08046

No	MARCA	APLICACIONES
1	UNIVERSAL	UNIVERSAL
2		
3		
4		



Cód. 1011152

TORNILLO TENSOR
ZINCADO VERDE

Cód. original: 53192-268-000

No	MARCA	APLICACIONES
1	HONDA	XLR 125
2	HONDA	XLR 125 BRASIL
3	HONDA	XLR 125 TT
4		



Cód. 1011153

TORNILLO TENSOR
ZINCADO VERDE

Cód. original: 53192-268-000

No	MARCA	APLICACIONES
1	HONDA	XL 100
2	HONDA	XLR 125
3	HONDA	XLR 125 BRASIL
4	HONDA	XLR 125 TT



Cód. 1011154

TORNILLO MANIGUETA
ZINCADO VERDE

Cód. original: 380020006-0002

No	MARCA	APLICACIONES
1	AKT	AK 125 SL
2	AKT	NKD 125
3		
4		



Cód. 1011155

TORNILLO MANIGUETA
ZINCADO BLANCO

Cód. original: 380020006-0002

No	MARCA	APLICACIONES
1	AKT	AK 125 SL
2	AKT	NKD 125
3		
4		



Cód. 1011156

TORNILLO MANIGUETA
ZINCADO VERDE

Cód. original: 57431-01011-IJ

No	MARCA	APLICACIONES
1	SUZUKI	AX 100
2	SUZUKI	FR 100
3		
4		



- Bandas de freno *Premium*
- Pastillas **JAPAN** *Premium Organics*
- Pastillas **JAPAN** *Premium Semimetallics*
- Pastillas **JAPAN** *Racing*
- Pastillas **JAPAN** *COMPETITION PRO*
- Pastillas **JAPAN** *Bike*
- Maniguetas
- Bases de Espejo
- Conjunto Base + Manigueta
- Discos de Freno
- Reposapiés
- Ejes de Rueda
- Ejes de Cambio
- Varillas de Freno
- Cuñas
- Pedales de Encendido
- Pedales de Cambio
- Pedales de Freno
- Tornillos
- Resortes de Banda
- Otros Productos
- Rines **Murelli**

Industrias Japan S.A



INDUSTRIAS JAPAN S.A.
Fabricantes de partes para motocicletas

Live safely





INDUSTRIAS JAPAN S.A. fabrica tornillos pivote para ensamble de maniguetas y bases de espejo, así como tornillos tensores de guaya específicos para determinados modelos de motocicletas, cumpliendo las dimensiones requeridas que garantiza un ajuste ideal del producto.

TORNILLOS



INDUSTRIAS JAPAN S.A. ofrece resortes específicos para bandas de freno de motocicleta fabricados en aceros especiales y en procesos automáticos que garantizan su funcionalidad y confiabilidad.

RESORTES DE BANDA

RESORTES BANDA DE FRENO



JAPAN
Frenos de Alto Desempeño

RESORTES BANDA DE FRENO



JAPAN
Frenos de Alto Desempeño



Cód. **101131**

Cód. original: 55421-45F00-000J

No	MARCA	APLICACIONES
1	BAJAJ	PLATINO 100 / PULSAR 180 / PULSAR 180 II
2	BAJAJ	PULSAR BLACK TEC 180 / PULSAR DTSI 180
3	BAJAJ	PULSAR UG 180
4	KAWASAKI	KE 100
5	SUZUKI	FZ 50 / FR 80 / AX 100 / FR 100 / TS 100 / AX 115
6	SUZUKI	EN 125 / GN 125 / GN 125 E / GN 125 H
7	SUZUKI	GN 125 NOVA / GS 125
8	YAMAHA	RX 100 / RX 100 INDU / RX 100 JAPON
9	YAMAHA	RX 115 / RX 115 S



Cód. **101132**

Cód. original: 43151-110-000

No	MARCA	APLICACIONES
1	AKT	AK 100 S
2	HONDA	C 90 / C 90 E
3	HONDA	ECO 100
4	HONDA	XL 100 / XL 185



Cód. **101133**

Cód. original: 90506-18288

No	MARCA	APLICACIONES
1	YAMAHA	DT 100 K
2		
3		
4		



Cód. **101136**

Cód. original: 078522

No	MARCA	APLICACIONES
1	PIAGGIO	PX 150
2		
3		
4		



Cód. **101137**

Cód. original: 90506-16150

No	MARCA	APLICACIONES
1	YAMAHA	RX 125
2	YAMAHA	RX 135
3	YAMAHA	RXZ 135
4	YAMAHA	DT 175 E



Cód. **101138**

Cód. original: 90506-15260

No	MARCA	APLICACIONES
1	YAMAHA	LB 80 CHAPPY
2	YAMAHA	V 80
3	YAMAHA	RX 100 JAPON
4	YAMAHA	LIBERO 125



Cód. **101139**

Cód. original: 45133-028-000

No	MARCA	APLICACIONES
1	AKT	AK 110
2	HONDA	C 70
3	KYMCO	ACTIV 110
4	SUZUKI	BEST 125



Cód. **1011311**

Cód. original: 01-1501-05

No	MARCA	APLICACIONES
1	BAJAJ	PLUS 150
2		
3		
4		



Cód. **1011313**

Cód. original: 43151-GC4-000

No	MARCA	APLICACIONES
1	HONDA	DIO 50
2		
3		
4		



Cód. **1011314**

Cód. original: 43151-329-000

No	MARCA	APLICACIONES
1	HONDA	PRESSCUB 50 / C 100 BIZ / CD 100 / ECO 100
2	HONDA	PASSION 100 / PASSION PRO 100
3	HONDA	SPLENDOR 100 / CG 125 / XLR 125
4	HONDA	XLR 125 BRASIL / XLR 125 TT



Cód. **1011315**

Cód. original: 90506-14081

No	MARCA	APLICACIONES
1	YAMAHA	CY 50 JOG
2		
3		
4		



Cód. **1011340**

RESORTE
GUADAÑA SHINDAIWA

Cód. original: 20021-51120

No	MARCA	APLICACIONES
1	SHINDAIWA	B 45
2	SHINDAIWA	C 35
3		
4		



- Bandas de freno *Premium*
- Pastillas **JAPAN** *Premium Organics*
- Pastillas **JAPAN** *Premium Semimetallics*
- Pastillas **JAPAN** *Racing*
- Pastillas **JAPAN** *COMPETITION PRO*
- Pastillas **JAPAN** *Bike*
- Maniguetas
- Bases de Espejo
- Conjunto Base + Manigueta
- Discos de Freno
- Reposapiés
- Ejes de Rueda
- Ejes de Cambio
- Varillas de Freno
- Cuñas
- Pedales de Encendido
- Pedales de Cambio
- Pedales de Freno
- Tornillos
- Resortes de Banda
- Otros Productos
- Rines **Murelli**

Industrias Japan S.A



INDUSTRIAS JAPAN S.A.
Fabricantes de partes para motocicletas

Live safely





**REFUERZO
GUARDABARRO**



**TENSOR
DE CADENA**



PORTABANDAS

OTROS PRODUCTOS



JAPAN
Frenos de Alto Desempeño

OTROS PRODUCTOS



JAPAN
Frenos de Alto Desempeño



Cód. 101931 PORTABANDAS DELANTERO

Cód. original: 31151039

No	MARCA	APLICACIONES	D	T
1	BAJAJ	BOXER CT 100 ES	X	
2	BAJAJ	BOXER CT 100 ES TITANIUM	X	
3	BAJAJ	BOXER CT 100 KS	X	
4				



Cód. 1019310 PORTABANDAS TRASERO

Cód. original: 31151024

No	MARCA	APLICACIONES	D	T
1	BAJAJ	BOXER 100 CARGUERA		X
2	BAJAJ	BOXER CARGO CT 100		X
3	BAJAJ	BOXER CT 100		X
4	BAJAJ	BOXER CT 100 KS - BOXER CT 100 ES		X



Cód. 10123223 SOPORTE SILENCIADOR

Cód. original: 2A6-14772-00-00

No	MARCA	APLICACIONES
1	YAMAHA	DT 125 - DT 125 D - DT 125 DS
2	YAMAHA	DT 175 - DT 175 D
3	YAMAHA	DT 175 E
4	YAMAHA	DTK 125 - DTK 175



Cód. 101291 ACUTRAX DE ALUMINIO

Cód. original: 3TL-F3441-50

No	MARCA	APLICACIONES
1	HONDA	ECO 100 / DTK 175
2	YAMAHA	DT 100 / DT 125 / DT 125 D / DT 125 DS / DTK 125
3	YAMAHA	DT 175 C / DT 175 D / DT 175 E / DT 175 F
4		



Cód. 101292 TAPÓN PARA MANUBRIO ALUMINIO CROMADO

Cód. original: -

No	MARCA	APLICACIONES
1	SUZUKI	TS 100
2		
3		
4		



Cód. 101331 BRAZO LEVA DE FRENO

Cód. original: 43410-KL4-000

No	MARCA	APLICACIONES
1	HONDA	XLR 125
2	HONDA	XLR 125 BRASIL
3	HONDA	XLR 125 TT
4		



Cód. 101371 EMBRAGUE DE GUADANADORA

Cód. original: 20021-51102

No	MARCA	APLICACIONES
1	SHINDAIWA	C 35
2	SHINDAIWA	B 45
3		
4		



Cód. 101491 REFUERZO DE GUARDABARRO

Cód. original: 5JV-F1513-00

No	MARCA	APLICACIONES
1	YAMAHA	RX 115
2	YAMAHA	RX 115 S
3		
4		



Cód. 101492 SOPORTE CORTAVIENTOS DERECHO

Cód. original: 4VP-F612N-01

No	MARCA	APLICACIONES
1	YAMAHA	BWS 100
2		
3		
4		



Cód. 101493 SOPORTE CORTAVIENTOS IZQUIERDO

Cód. original: 4VP-F612M-01

No	MARCA	APLICACIONES
1	YAMAHA	BWS 100
2		
3		
4		



Cód. 101501 DISCO FRISADOR

Cód. original: 3KJ-17611-00

No	MARCA	APLICACIONES
1	YAMAHA	CY 50 JOG
2		
3		
4		



Cód. 101031 CAPUCHON DE BUJIA

Cód. original: -

No	MARCA	APLICACIONES
1	UNIVERSAL	UNIVERSAL
2		
3		
4		

OTROS PRODUCTOS



JAPAN
Frenos de Alto Desempeño



Cód. 101532

ABRASADERA PARA TENSOR
IZQUIERDO Y DERECHO

Cód. original: -

No	MARCA	APLICACIONES
1	UNIVERSAL	UNIVERSAL
2		
3		
4		



Cód. 101587

DEFENSA

Cód. original: JZ231211

No	MARCA	APLICACIONES
1	BAJAJ	DISCOVER 125 ST
2		
3		
4		



Cód. 101589

DEFENSA

Cód. original: JZ231201

No	MARCA	APLICACIONES
1	BAJAJ	DISCOVER 100
2	BAJAJ	DISCOVER 125
3		
4		



Cód. 101591

BUJE ESPACIADOR
PINON

Cód. original: 90387-20491

No	MARCA	APLICACIONES
1	YAMAHA	RX 115
2	YAMAHA	RX 115 S
3		
4		



Cód. 101672

KIT DE TIJERA STORM

Cód. original: 52101-KVC-900

No	MARCA	APLICACIONES
1	HONDA	CB 125 E
2	HONDA	CGL 125
3	HONDA	CGL 125 ARO MAGNESIO
4	HONDA	E STORM 125



Cód. 10123185

KIT DE TIJERA

Cód. original: JK122011

No	MARCA	APLICACIONES
1	BAJAJ	PLATINO 100
2	BAJAJ	PLATINO 125 5 SPEED
3		
4		



Cód. 101631

TENSOR DE CADENA
IZQUIERDO

Cód. original: 5H5-25388-00

No	MARCA	APLICACIONES
1	YAMAHA	RX 100 / RX 100 INDU / RX 100 JAPON
2	YAMAHA	RX 115
3	YAMAHA	RX 115 S
4	YAMAHA	LIBERO 125



Cód. 101632

TENSOR DE CADENA
DERECHO

Cód. original: 5H5-25389-00

No	MARCA	APLICACIONES
1	YAMAHA	RX 100
2	YAMAHA	RX 100 INDU
3	YAMAHA	RX 100 JAPON
4	YAMAHA	RX 115 / RX 115 S



Cód. 101633

TENSOR DE CADENA
IZQUIERDO Y DERECHO

Cód. original: 40543-KBW-950

No	MARCA	APLICACIONES
1	HONDA	NXR 125 BROSS
2	HONDA	XR 125 L
3	HONDA	XR 150 L
4		



Cód. 101634

TENSOR DE CADENA
IZQUIERO Y DERECHO

Cód. original: 61410-23450

No	MARCA	APLICACIONES
1	SUZUKI	AX 100
2	SUZUKI	AX 115
3		
4		



Cód. 101635

TENSOR DE CADENA
IZQUIERDO

Cód. original: 61420-28003

No	MARCA	APLICACIONES
1	SUZUKI	TS 125 ER
2		
3		
4		



Cód. 101636

TENSOR DE CADENA
DERECHO

Cód. original: 61410-28004

No	MARCA	APLICACIONES
1	SUZUKI	TS 125 ER
2		
3		
4		

OTROS PRODUCTOS



JAPAN
Frenos de Alto Desempeño



Cód. **101639**

TENSOR DE CADENA
IZQUIERDO Y DERECHO

Cód. original: 5VL-F5388-01

No	MARCA	APLICACIONES
1	YAMAHA	YBR 125 DX
2		
3		
4		



Cód. **1016310**

TENSOR DE CADENA
IZQUIERDO Y DERECHO

Cód. original: 61410-36002

No	MARCA	APLICACIONES
1	SUZUKI	EN 125
2	SUZUKI	GN 125 / GN 125 E / GN 125 H
3	SUZUKI	GN 125 NOVA
4	SUZUKI	GS 125



Cód. **101061**

KIT DE GUAYA Y
LLAVE BRISTOL 5/64

Cód. original: -

No	MARCA	APLICACIONES
1	UNIVERSAL	UNIVERSAL



Cód. **101673**

KIT DE TIJERA

Cód. original: 90121-LBA8-C10

No	MARCA	APLICACIONES
1	KYMCO	ACTIV 110 - UNI K 110
2	AKT	AK 110
3	AKT	AK 110 SII
4	AKT	SPECIAL X 110



Cód. **1016712**

KIT DE TIJERA

Cód. original: DZ-1710-07

No	MARCA	APLICACIONES
1	BAJAJ	PLATINO 100
2		
3		
4		



Cód. **1016711**

KIT TIJERA -BUSHING

Cód. original: JK122006

No	MARCA	APLICACIONES
1	BAJAJ	PLATINO 100
2		
3		
4		



Cód. **101081**

PIN DE PINÓN
LAINA

Cód. original: 36L-F5412-00

No	MARCA	APLICACIONES
1	YAMAHA	V 80
2	YAMAHA	RX 100 / RX 100 INDU / RX 100 JAPON
3	YAMAHA	RX 115 / RX 115 S
4		



Cód. **101062**

TERMINAL DE GUAYA

Cód. original: TG-SENC-M3-IJ

No	MARCA	APLICACIONES
1		STREET FIGHTER
2		
3		
4		



Cód. **101063**

5/64 ALLEN KEY

Cód. original: LLA-ALLEN5/64-IJ

No	MARCA	APLICACIONES
1		STREET FIGHTER
2		
3		
4		



Cód. **101494**

REFUERZO
GUARDABARRO

Cód. original: 340310393-0008

No	MARCA	APLICACIONES
1	UNIVERSAL	UNIVERSAL
2		
3		
4		



Cód. **101638**

TENSOR DE CADENA
IZQUIERDO

Cód. original: 214-25388-00

No	MARCA	APLICACIONES
1	YAMAHA	RXZ 135
2		
3		
4		



Cód. **101882**

EJE TIJERA

Cód. original: 52101-KVC-900

No	MARCA	APLICACIONES
1	HONDA	CB 125 E
2	HONDA	CGL 125
3	HONDA	CGL 125 ARO MAGNESIO
4	HONDA	E STORM 125

OTROS PRODUCTOS



JAPAN
Frenos de Alto Desempeño



Cód. **1015123**

ARTICULACIÓN
LARGA PEDAL

Cód. original: 45525-625

No	MARCA	APLICACIONES
1	AYCO	MOTOCARRO AY 250 ZH-2
2		
3		
4		



Cód. **1015124**

ARTICULACIÓN
CORTA PEDAL

Cód. original: 45525-630

No	MARCA	APLICACIONES
1	AYCO	MOTOCARRO AY 250 ZH-3
2		
3		
4		



- Bandas de freno *Premium*
- Pastillas **JAPAN** *Premium Organics*
- Pastillas **JAPAN** *Premium Semimetallics*
- Pastillas **JAPAN** *Racing*
- Pastillas **JAPAN** *COMPETITION PRO*
- Pastillas **JAPAN** *Bike*
- Maniguetas
- Bases de Espejo
- Conjunto Base + Manigueta
- Discos de Freno
- Reposapiés
- Ejes de Rueda
- Ejes de Cambio
- Varillas de Freno
- Cuñas
- Pedales de Encendido
- Pedales de Cambio
- Pedales de Freno
- Tornillos
- Resortes de Banda
- Otros Productos
- Rines **Murelli**

Industrias Japan S.A



INDUSTRIAS JAPAN S.A.
Fabricantes de partes para motocicletas

Live safely

